

OXFORD

مرجع زبان ایرانیان

LET'S  
BEGIN  
1

WORKBOOK

# LET'S GO

5th  
Edition

مرجع آموزش زبان ایرانیان  
www.irLanguage.com

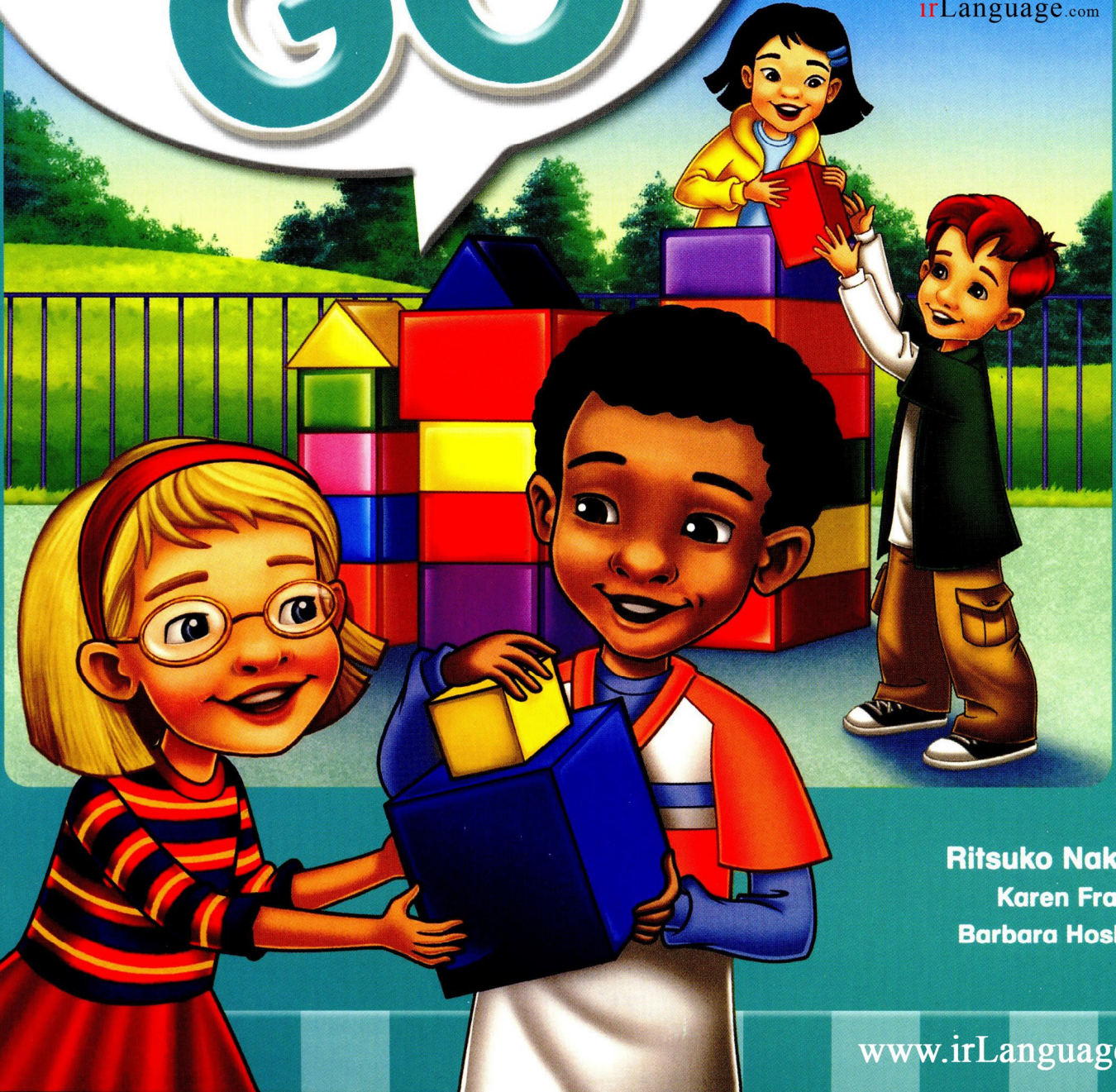

Ritsuko Nakata  
Karen Frazier  
Barbara Hoskins

www.irLanguage.com



# WORKBOOK

LET'S  
BEGIN

1

# LET'S GO

5th  
Edition

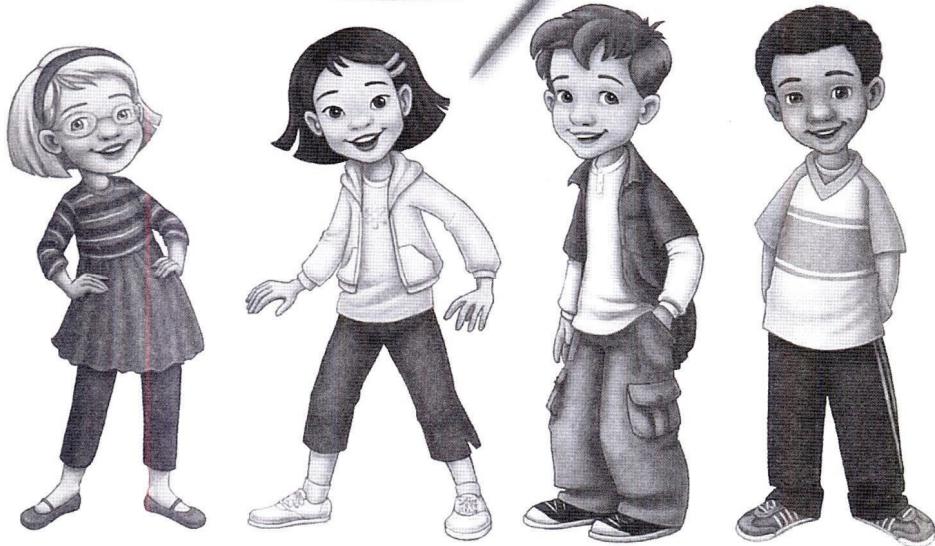

مرجع آموزش زبان ایرانیان



این مجموعه با لوگوی مرجع زبان ایرانیان به صورت نشر بر خط و حامل به ثبت رسیده است. به ثبت رسیده است. کپی برداری از آن خلاف شرع، قانون و اخلاق است و شامل پیگیری خواهد شد.



# Table of Contents

Lessons 1-5	The Vowels . . . . .	4
	Aa, Ee, Ii, Oo, Uu	
Lessons 6-13	The EE Group . . . . .	14
	Cc, Gg, Bb, Dd, Pp, Tt, Vv, Zz	
Lessons 14-19	The EH Group . . . . .	30
	Ff, Ll, Mm, Nn, Ss, Xx	
Lessons 20-21	The EI Group . . . . .	42
	Jj, Kk	
Lessons 22-26	The Mixed Group. . . . .	46
	Hh, Qq, Rr, Ww, Yy	
Lesson 27	The Alphabet . . . . .	56
Lesson 28	Goodbye! . . . . .	58
Phonics Practice	. . . . .	60

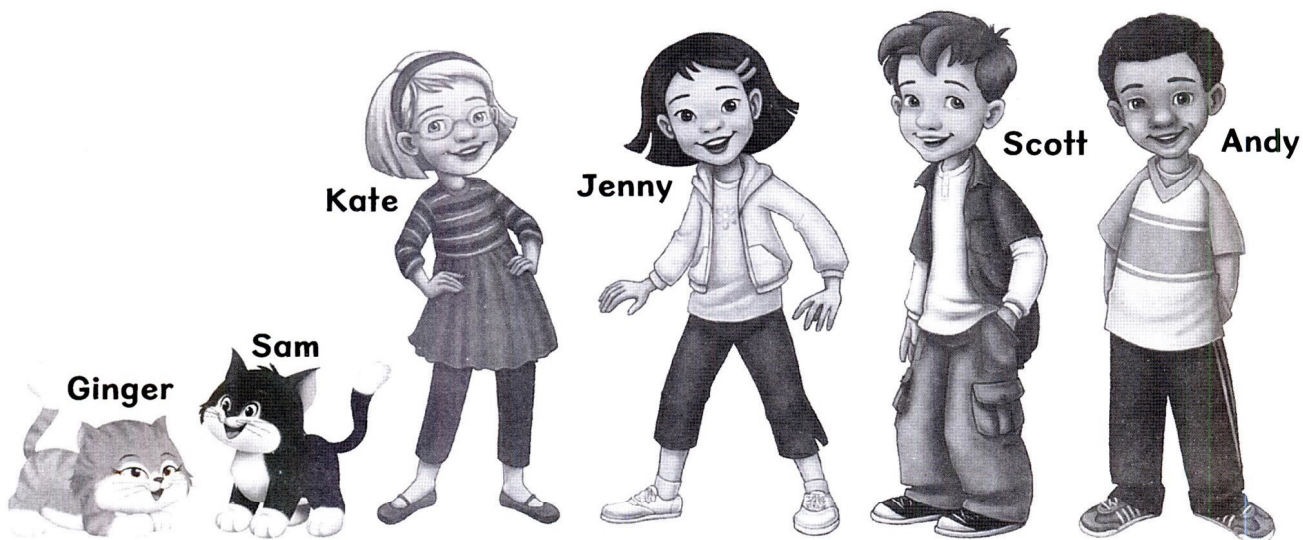



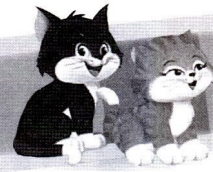

## A Trace. Write.

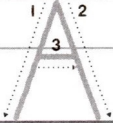

## B Follow. Trace. Color.

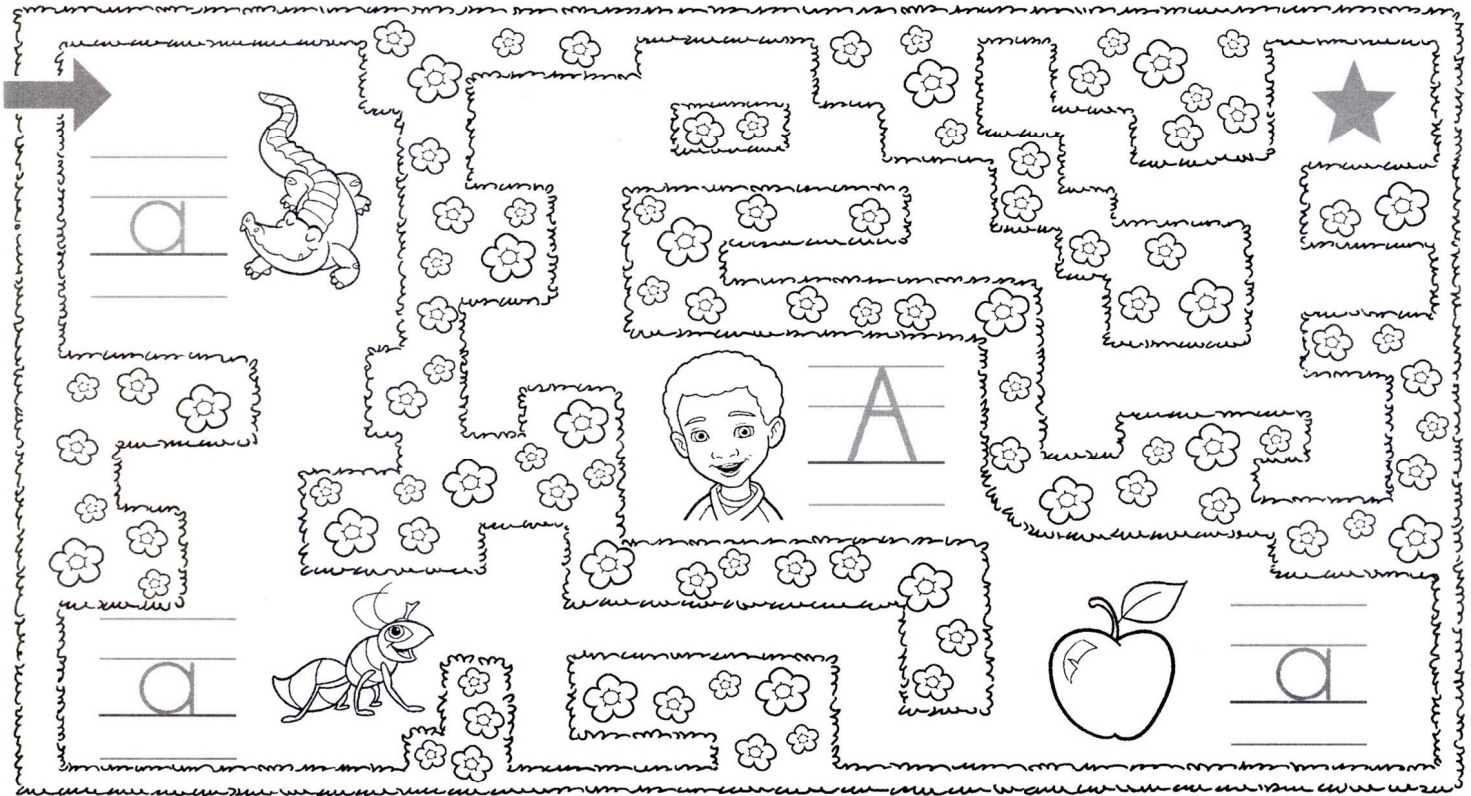



# Let's Talk

مرجع آموزش زبان ایرانیان



**Color.**



✓ Parent's signature: \_\_\_\_\_



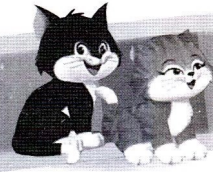

**A Trace. Write.**

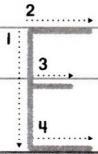

**B Connect. Trace. Color.**

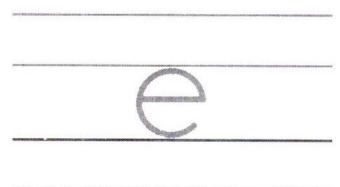
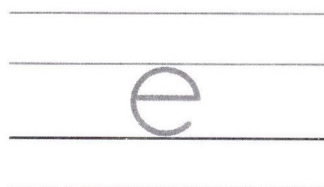
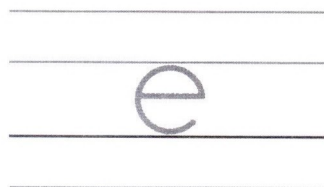
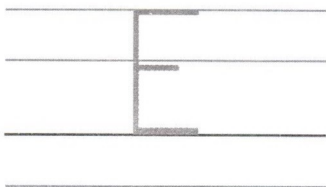
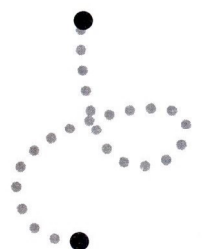
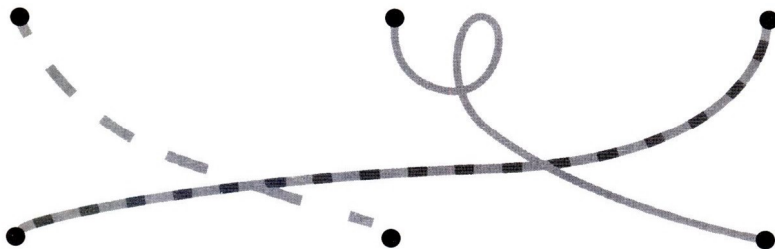
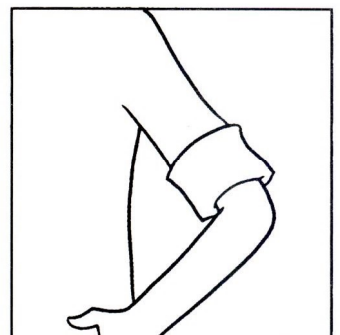
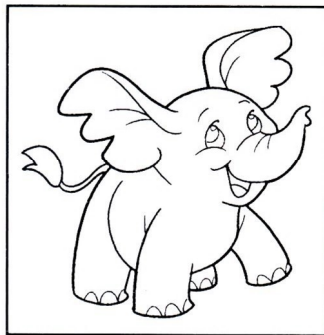
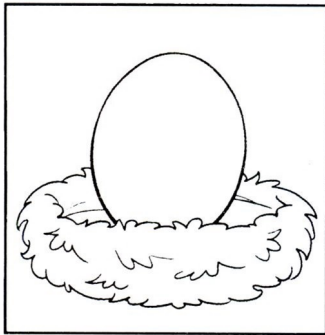



# Let's Talk

## C Color.

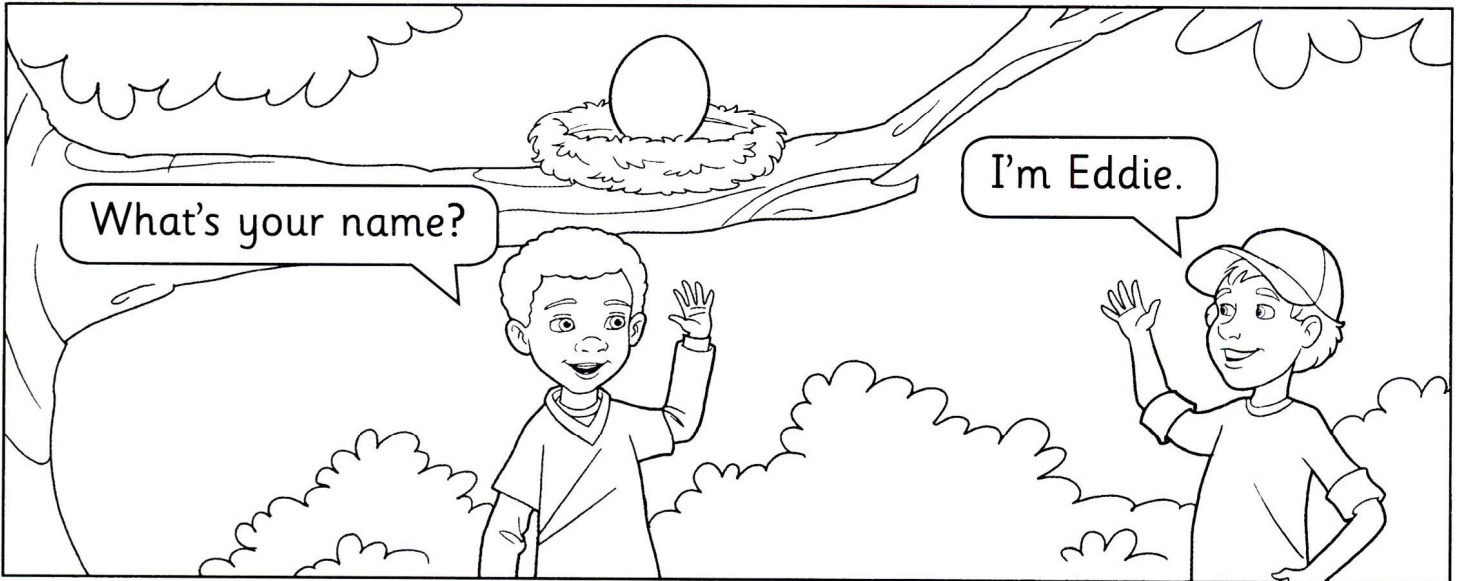

## D Answer. Draw. Color.

What's your name? I'm

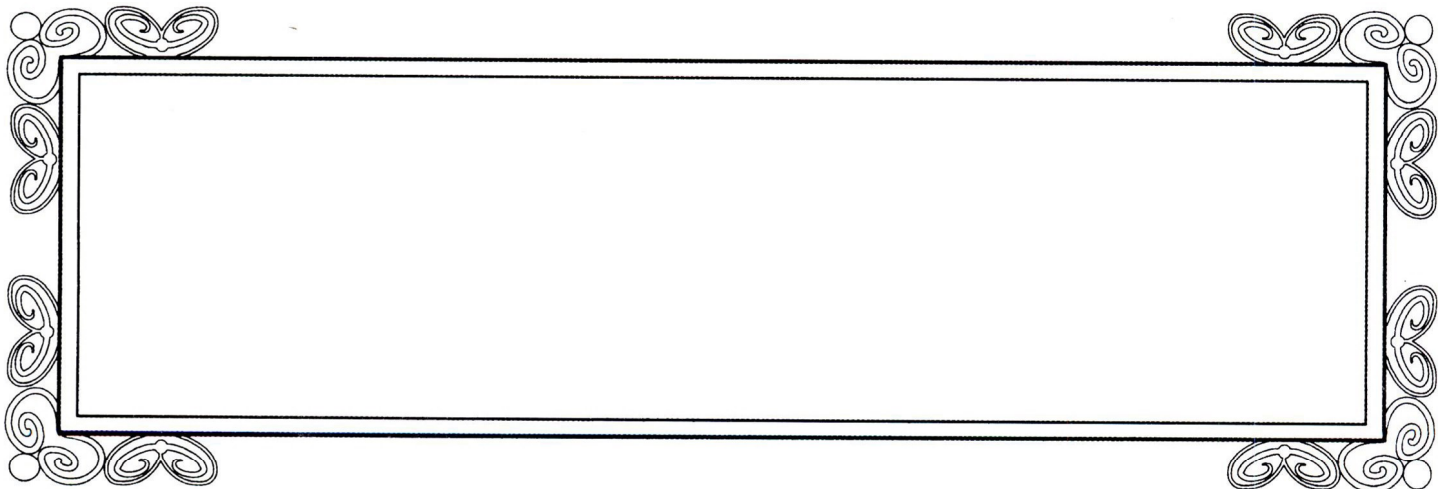

✓ Parent's signature: \_\_\_\_\_



Lesson 3

Ii

Let's Learn



**A** Trace. Write.

Tracing practice for uppercase 'I' and lowercase 'i'. The first row shows a large uppercase 'I' with stroke order arrows: 1 (down), 2 (top bar), and 3 (bottom bar). Below it are two sets of blank handwriting lines for practice. The second row shows a small lowercase 'i' with stroke order arrows: 1 (down) and 2 (dot). Below it are two sets of blank handwriting lines for practice.

**B** Match. Color.

Match and color activity. On the left, there are three items: a watermelon, a slice of watermelon, and a watermelon rind. In the middle, there are two items: a cartoon character and a large letter 'I'. On the right, there are three items: a cartoon character, a lowercase letter 'i', and a watermelon rind. A dashed line connects the watermelon on the left to the watermelon rind on the right.



# Let's Talk

## Color.



✓ Parent's signature: \_\_\_\_\_





**A** Trace. Write.

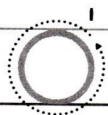
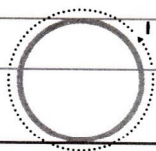

**B** Circle the "o" pictures. Color.

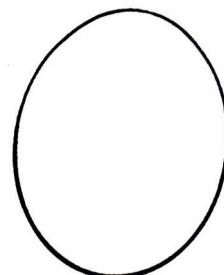
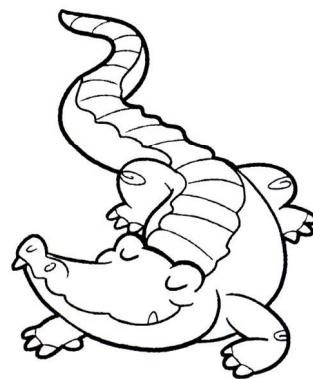
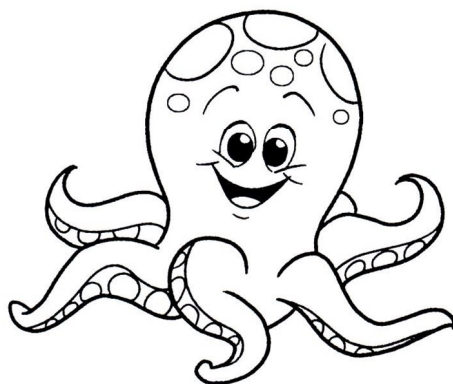
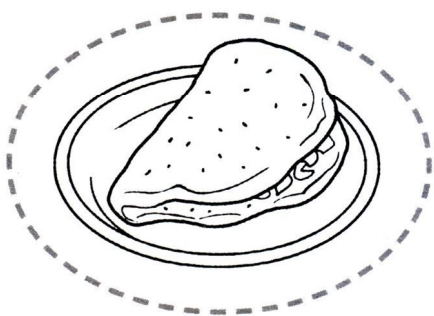

# Let's Talk

What is it?

It's a ball.

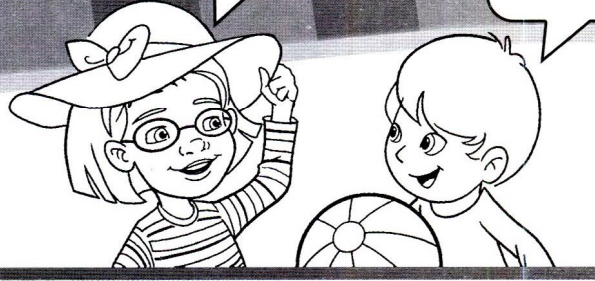

## Match. Color.

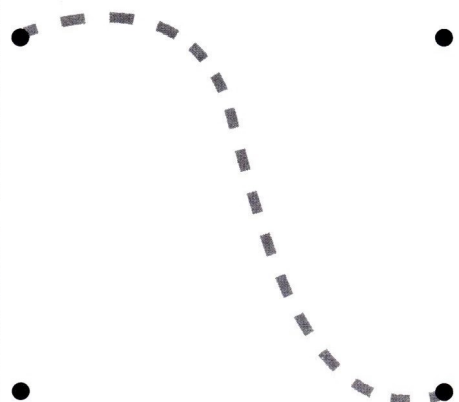
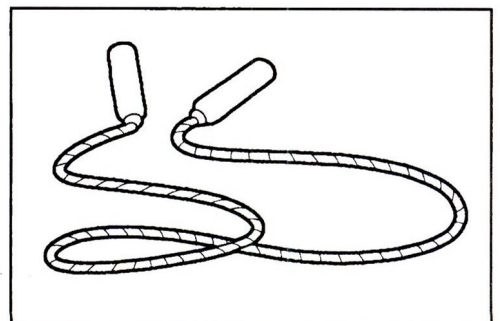
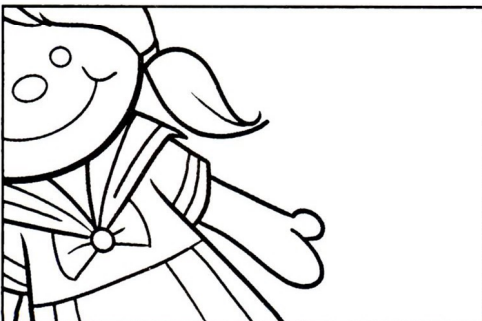
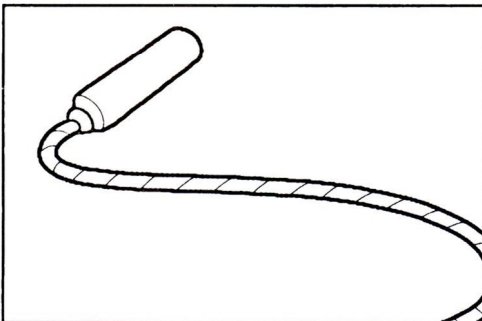
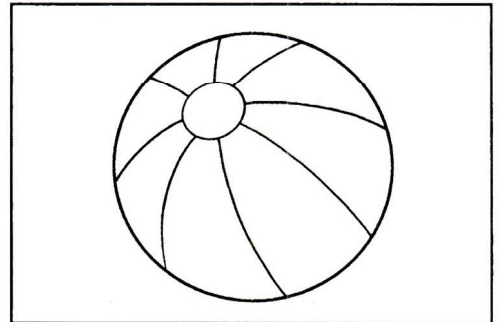
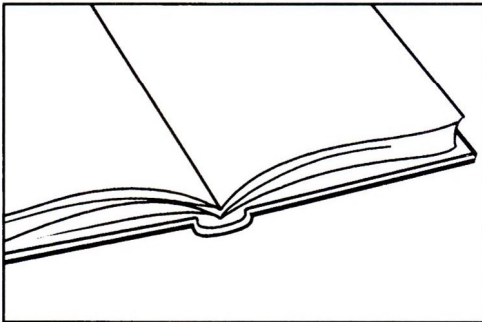
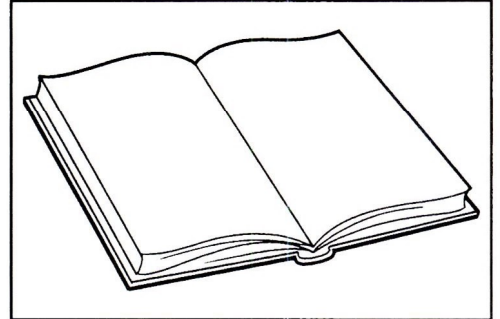
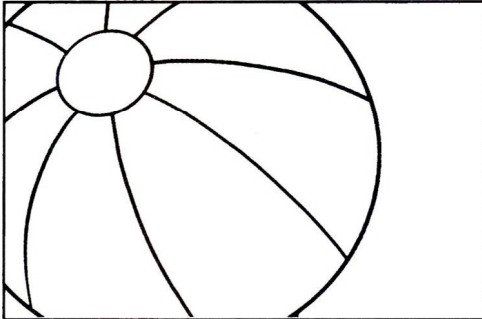

✓ Parent's signature: \_\_\_\_\_



Lesson 5

Uu

Let's Learn

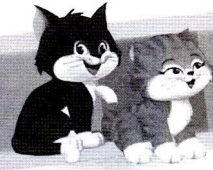

**A** Trace. Write.

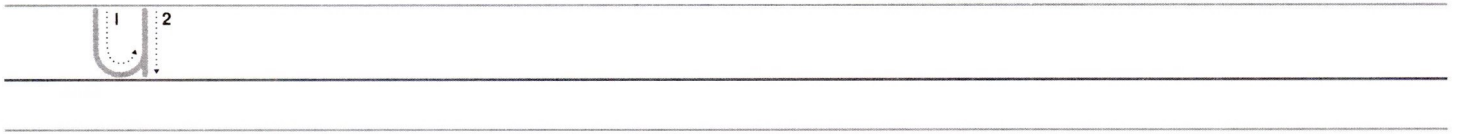
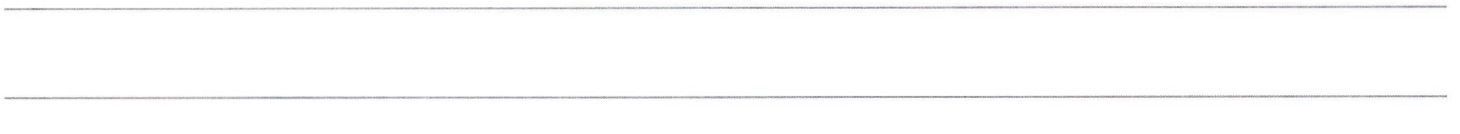
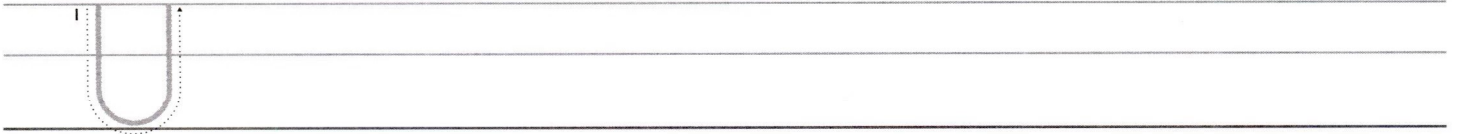

**B** Follow. Trace. Color.

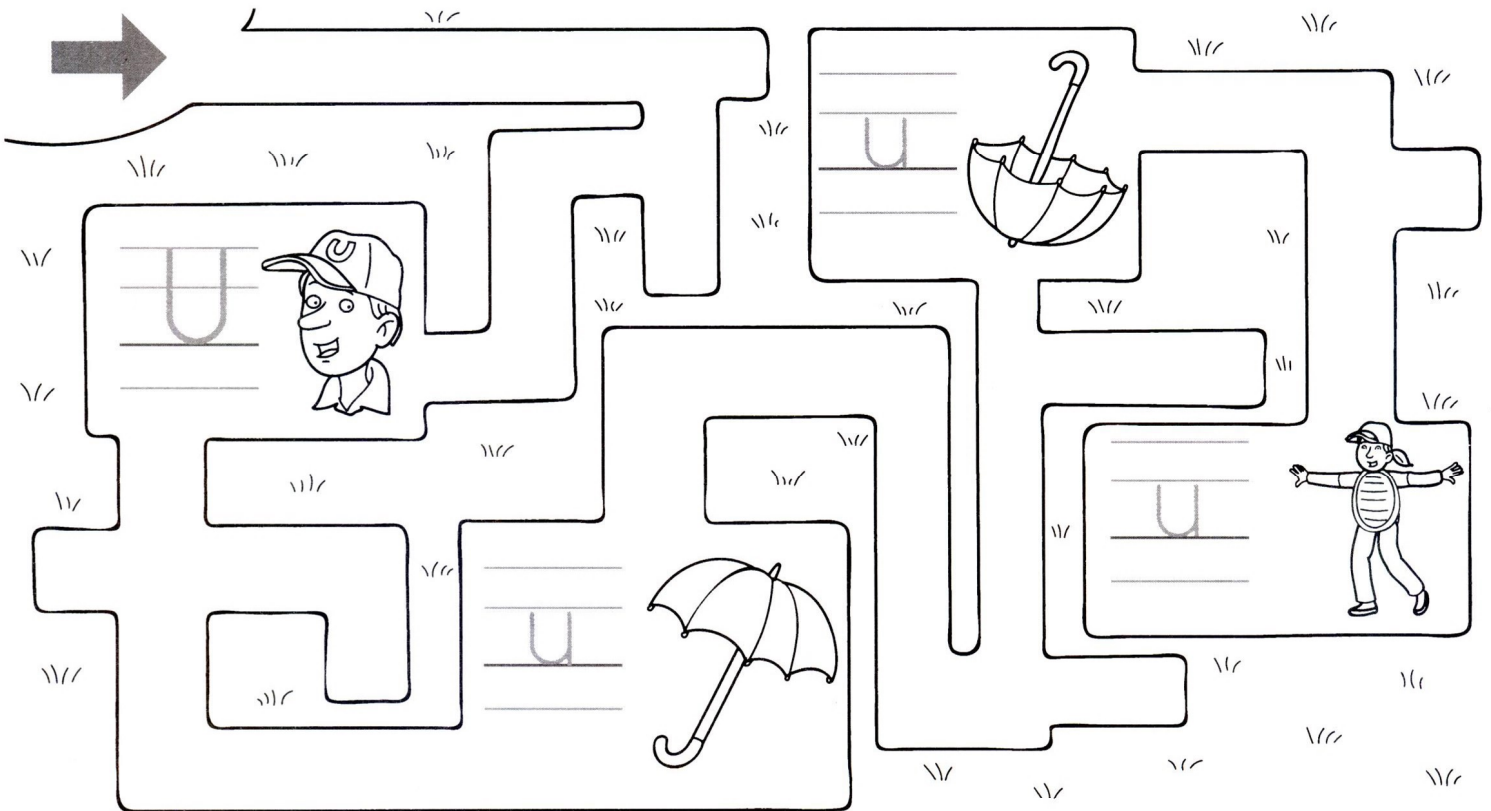

# Let's Talk

What is it?

It's a balloon.



## C Match. Color.

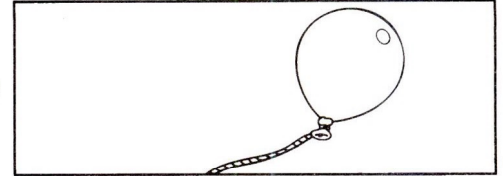
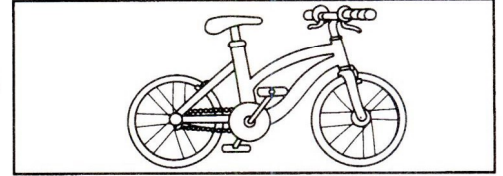
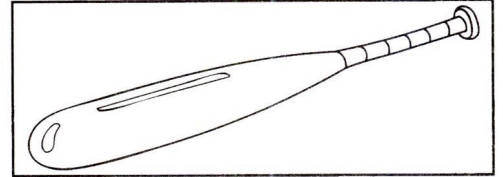
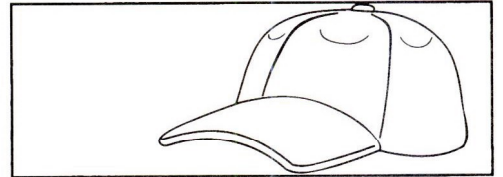
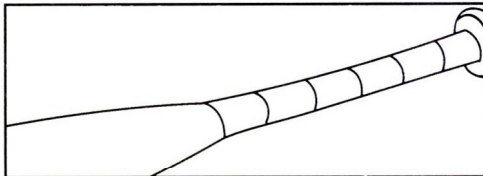
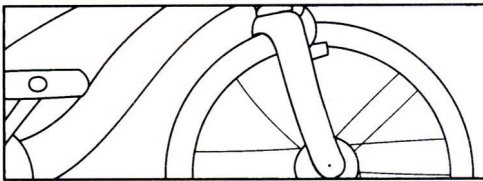
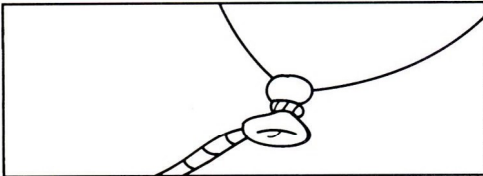

## D Match. Color.

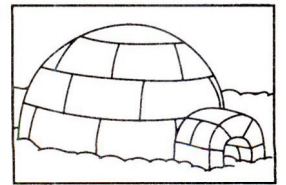
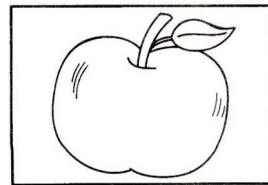
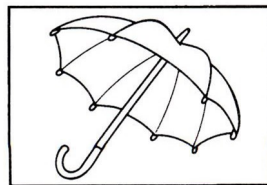
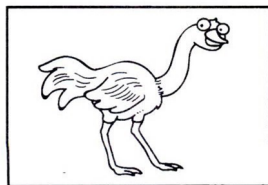
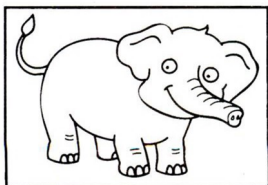
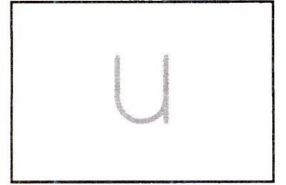
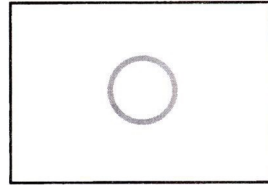
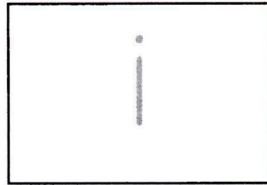
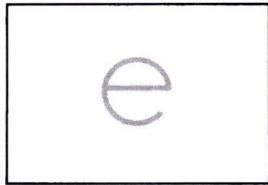
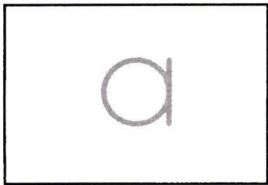

✓ Parent's signature: \_\_\_\_\_





**A** Trace. Write.

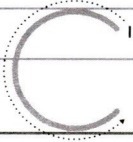

**B** Find. Color.

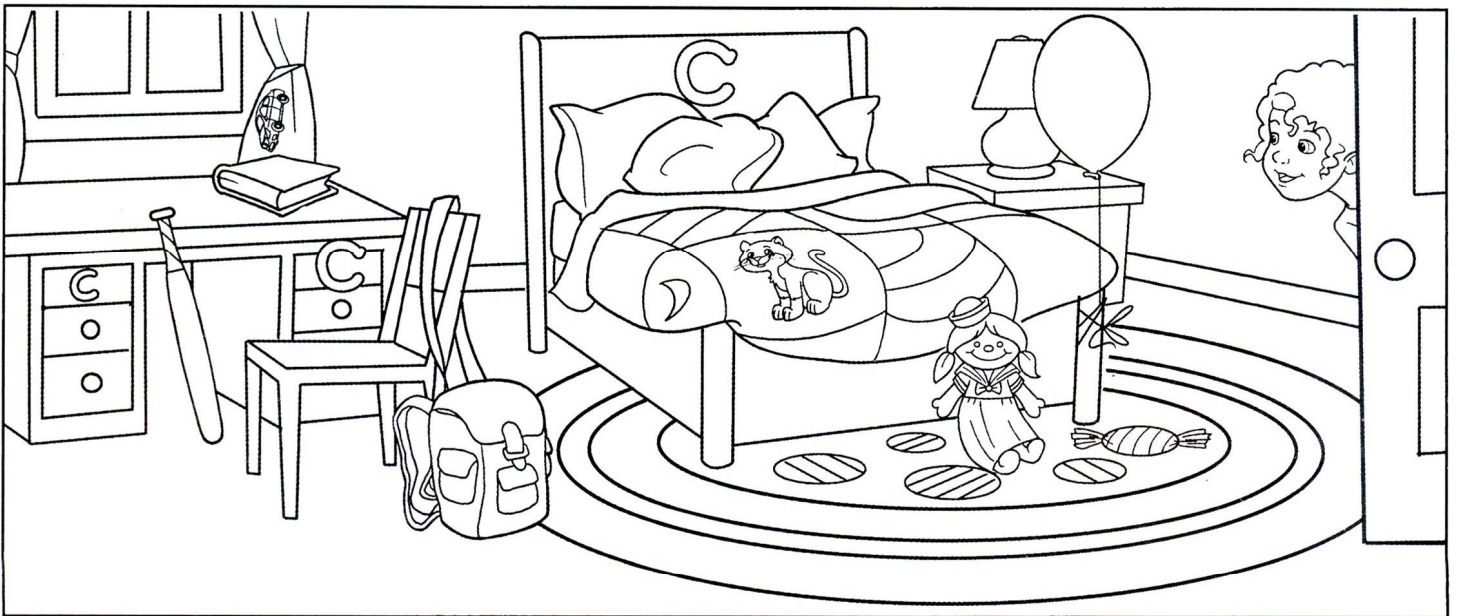
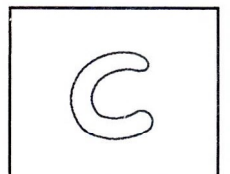
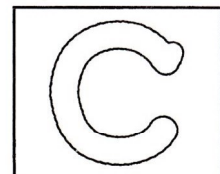
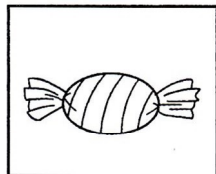
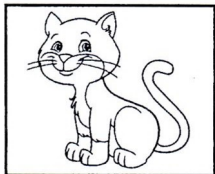
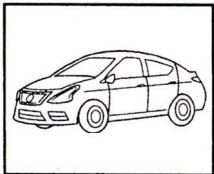

# Let's Talk

Let's count!

OK! 1!



## C Count. Match. Color.

1 2 3 4 5

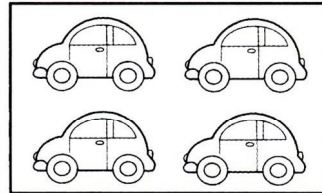
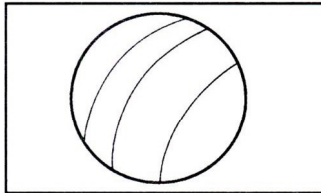
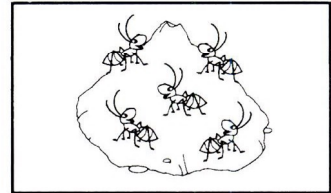
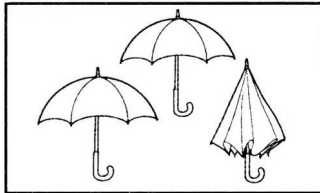
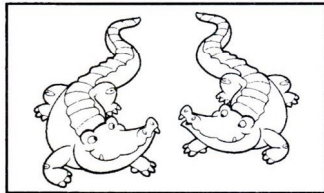

## D Connect the numbers. Color.

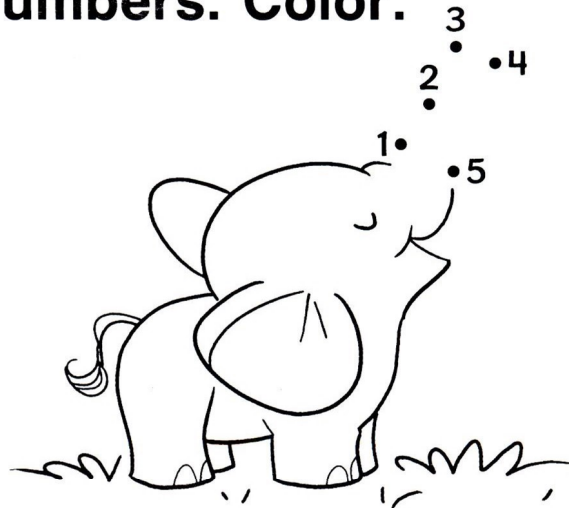

✓ Parent's signature: \_\_\_\_\_



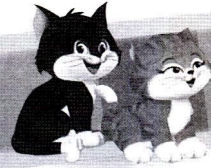

**A Trace. Write.**

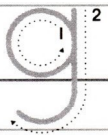
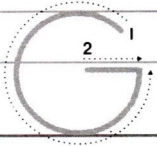

**B Follow. Trace. Color.**

# Let's Talk

Let's count!

OK! 6!

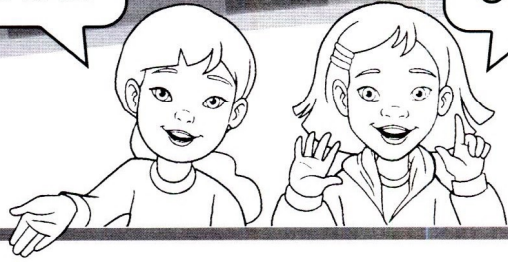

## C Count. Match. Color.

6 7 8 9 10

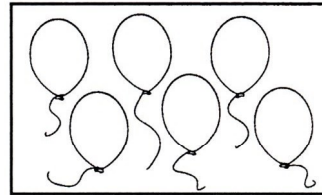
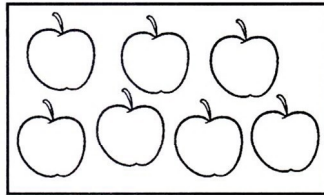
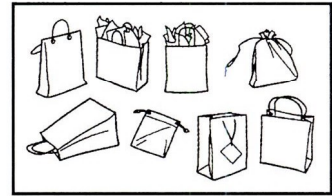
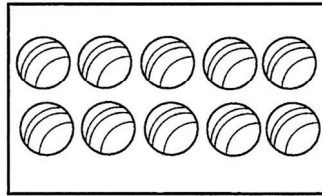
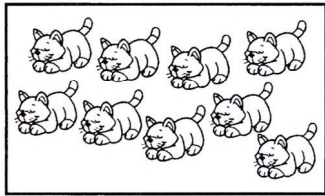

## D Connect the numbers. Color.

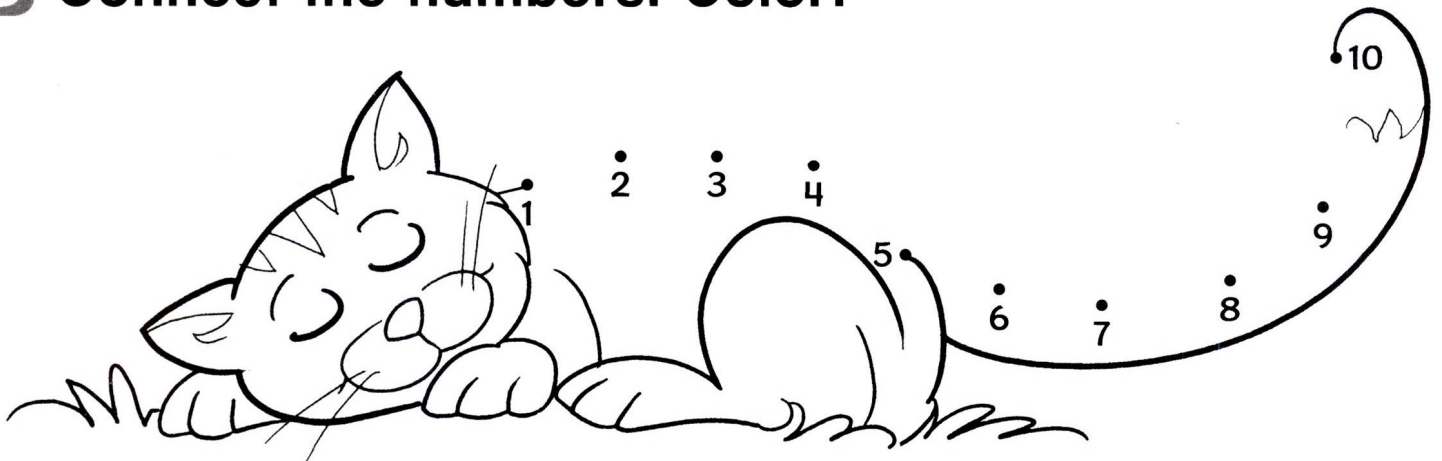

✓ Parent's signature: \_\_\_\_\_



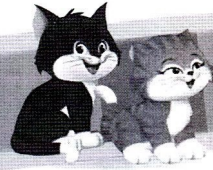

### A Trace. Write.

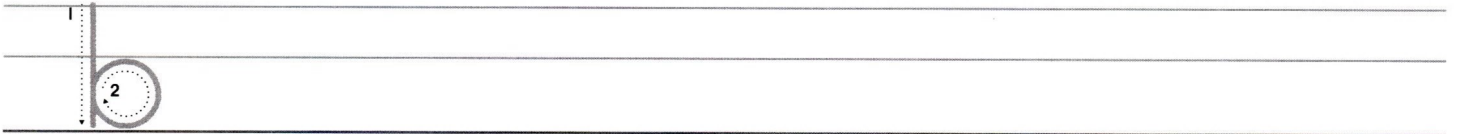
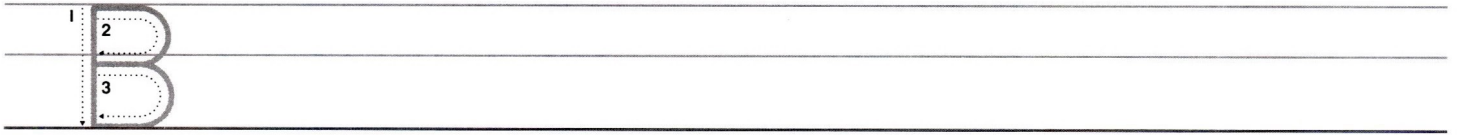

### B Match. Color.

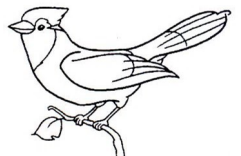
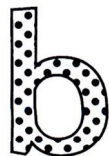
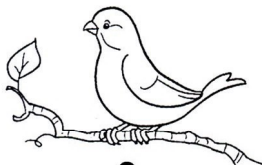
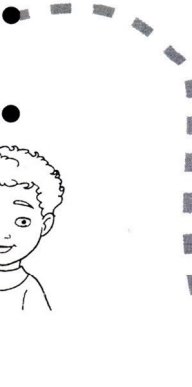
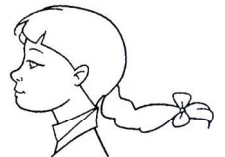

# Let's Talk

How many?

7!

**C** Count. Write. Color.

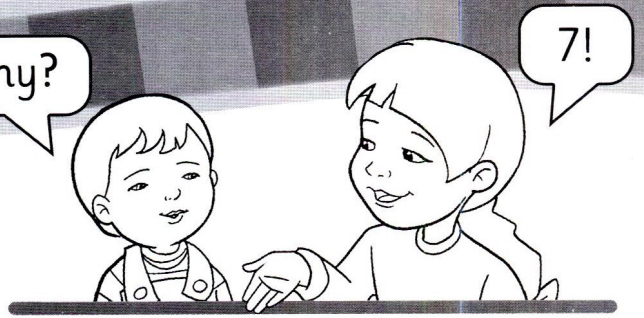

1 2 3 4 5 6 7 8 9 10

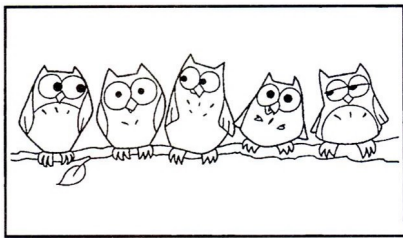

5

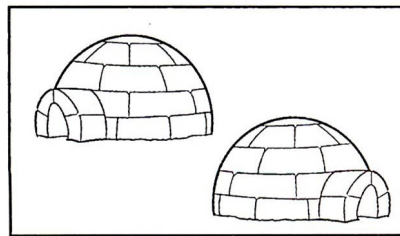
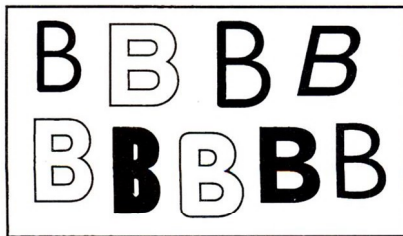
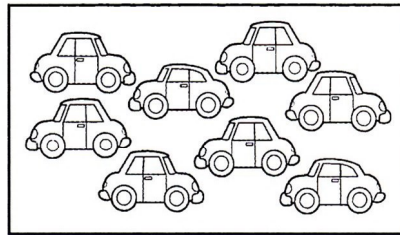
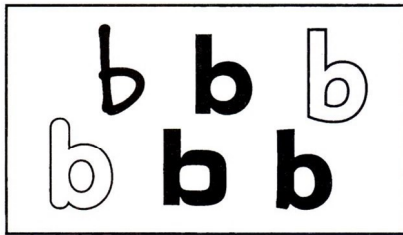
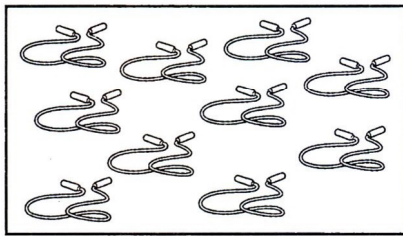
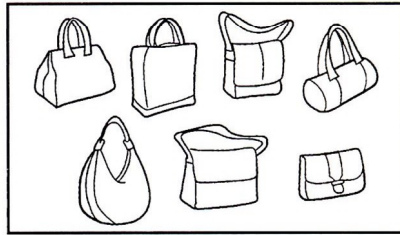
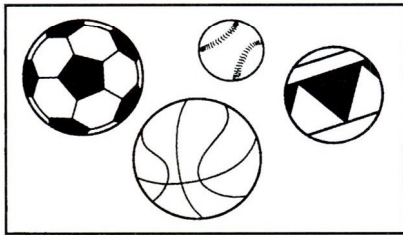
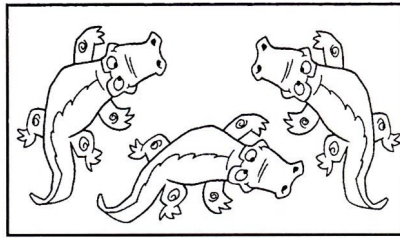

✓ Parent's signature: \_\_\_\_\_



Lesson 9

# Dd

## Let's Learn



### A Trace. Write.

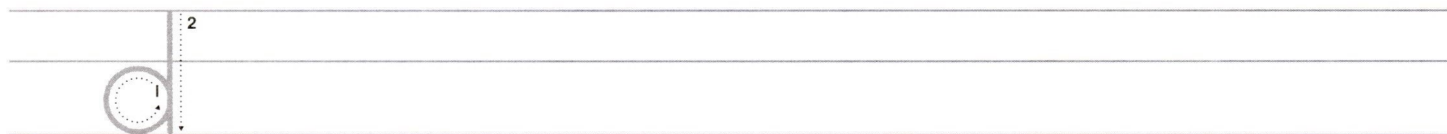
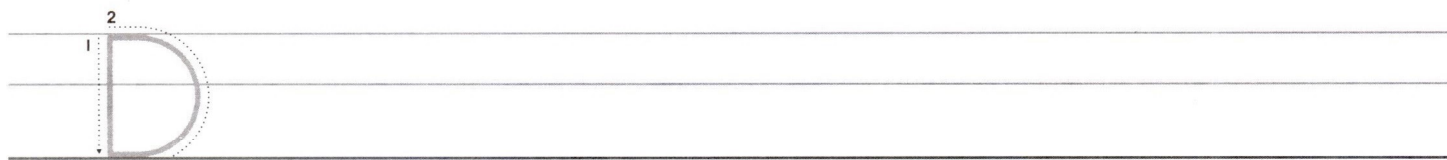

### B Match. Color.

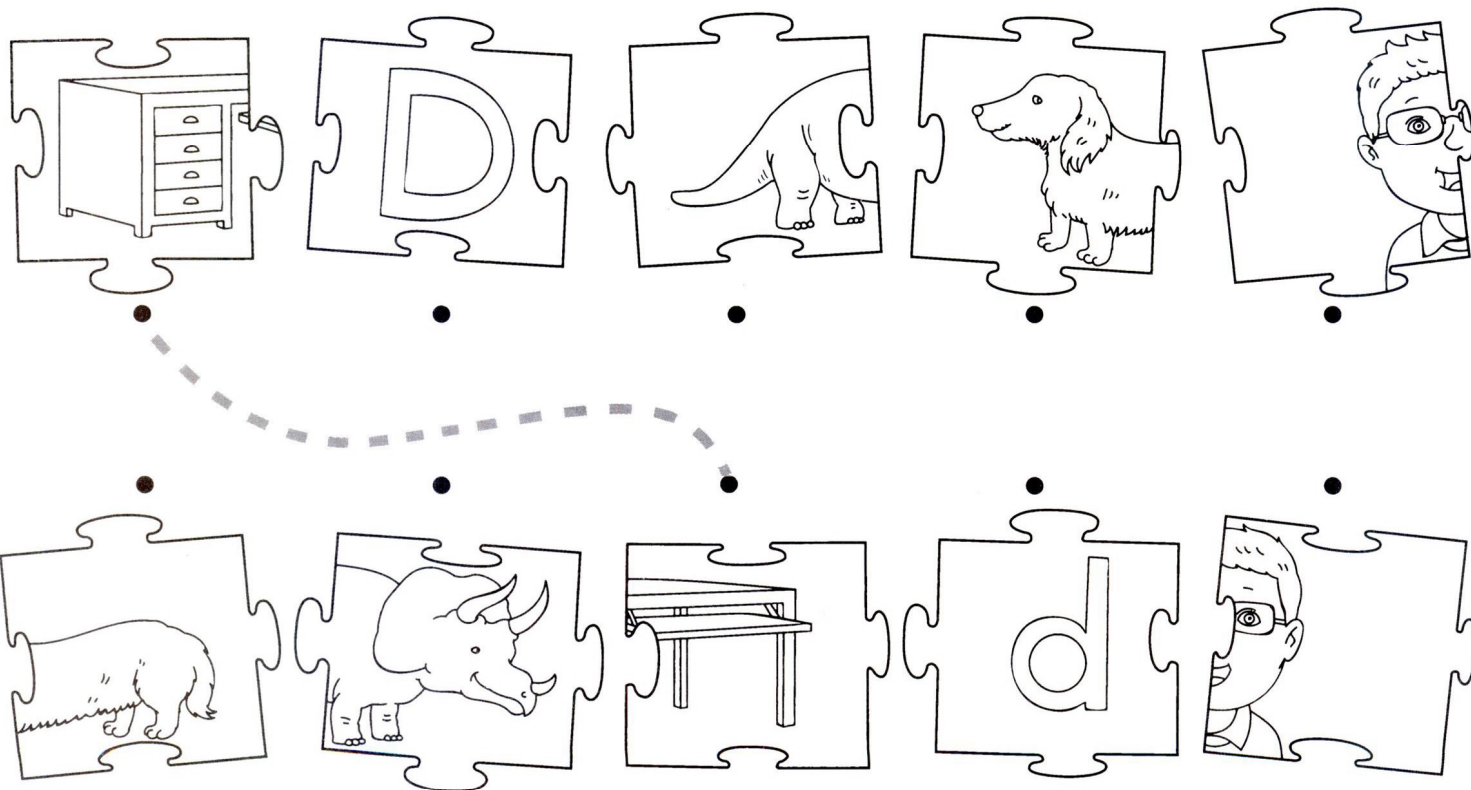

# Let's Talk

How old are you?

I'm 7.



## C Count. Write. Color.



5



\_\_\_\_\_



\_\_\_\_\_

## D Answer. Draw. Color.

How old are you?

I'm \_\_\_\_\_

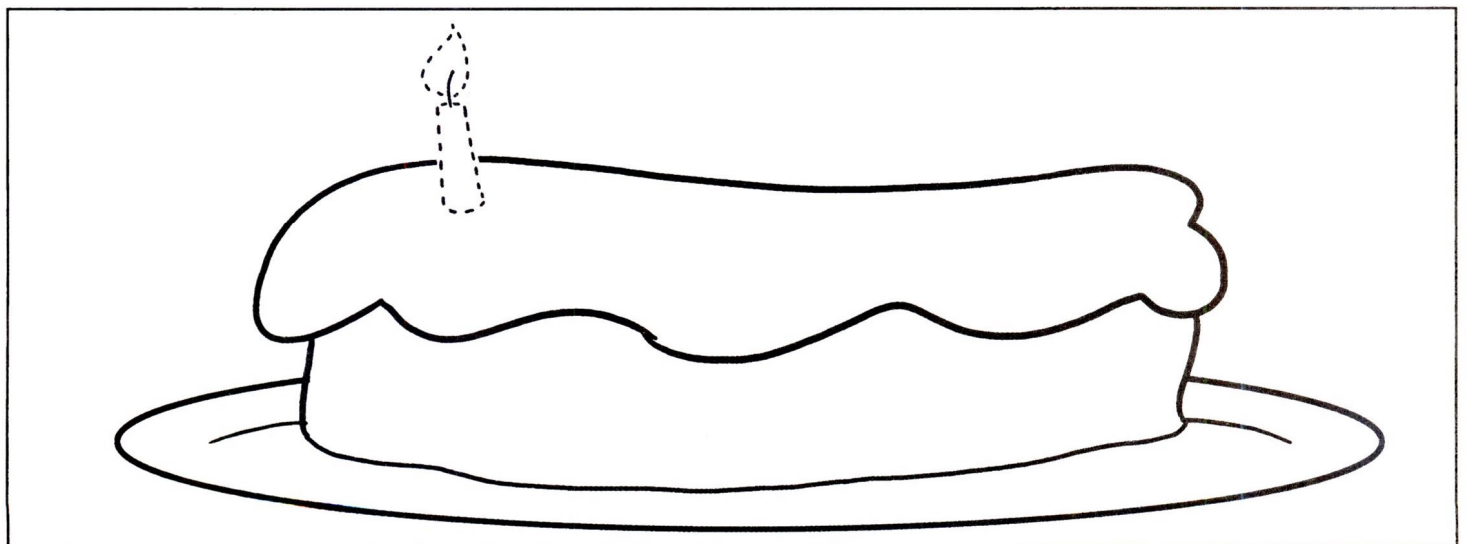

✓ Parent's signature: \_\_\_\_\_



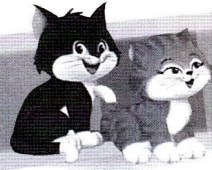

**A** Trace. Write.

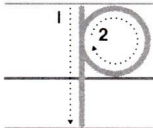
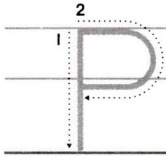

**B** Trace. Color.

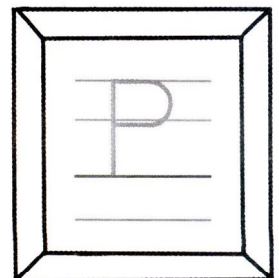
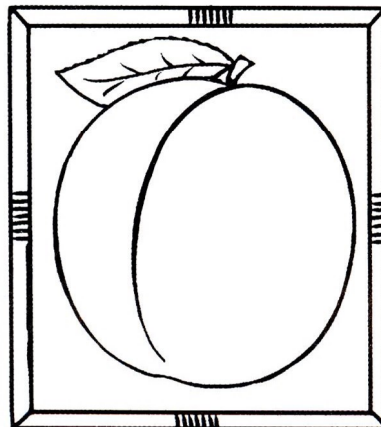
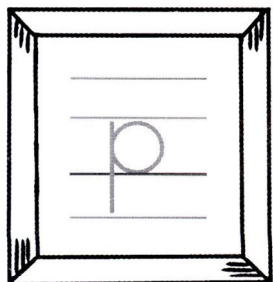
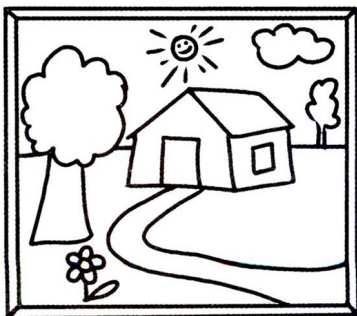
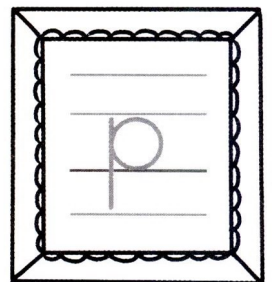
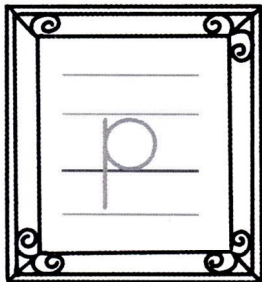
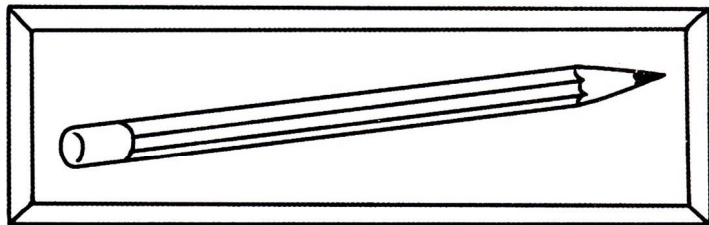
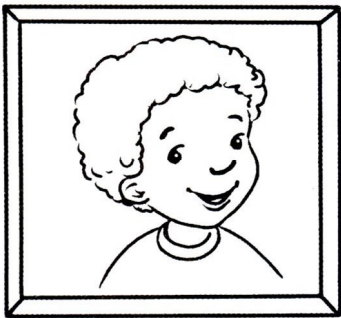

# Let's Talk

**Color.**

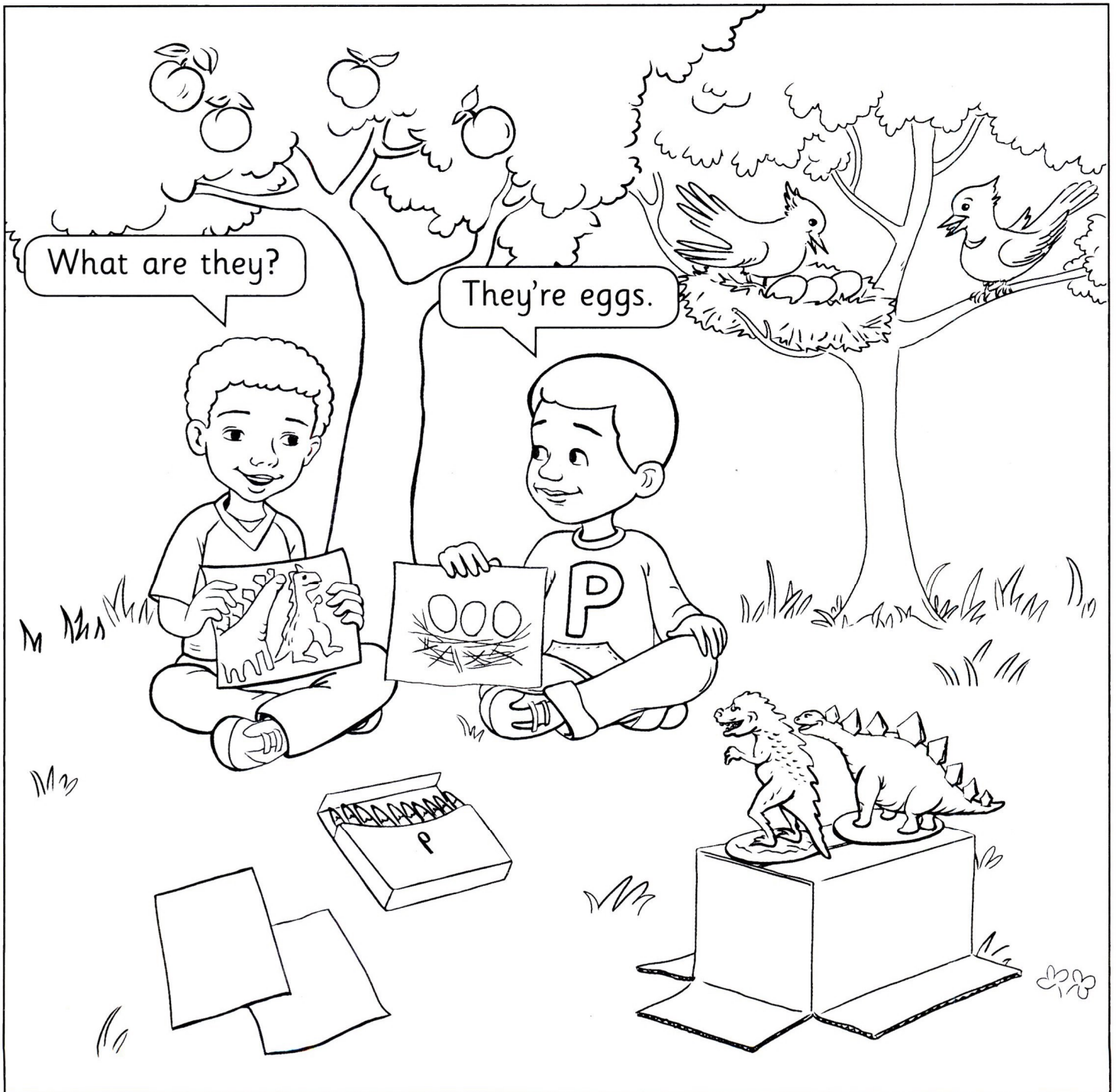

✓ Parent's signature: \_\_\_\_\_





**A** Trace. Write.

Tracing practice for uppercase 'T' and lowercase 't'. The first row shows a dotted uppercase 'T' with stroke order arrows: '1' for the vertical line and '2' for the top bar. Below it are two sets of blank handwriting lines. The second row shows a dotted lowercase 't' with stroke order arrows: '1' for the vertical line and '2' for the top bar. Below it are two sets of blank handwriting lines.

**B** Connect. Trace. Color.

Activity B includes four boxes with line drawings: a television, a table, a mobile phone on a charging dock, and a boy's face. Below these are four paths: a dashed line connecting the TV to the table, a solid wavy line connecting the table to the phone, a dotted line connecting the phone to the boy, and a solid curved line connecting the boy to the TV. Below each path is a set of handwriting lines with a dotted uppercase 'T' for tracing and a solid uppercase 'T' for coloring.

# Let's Talk

What are they?

They're cars.



## C Match. Color.

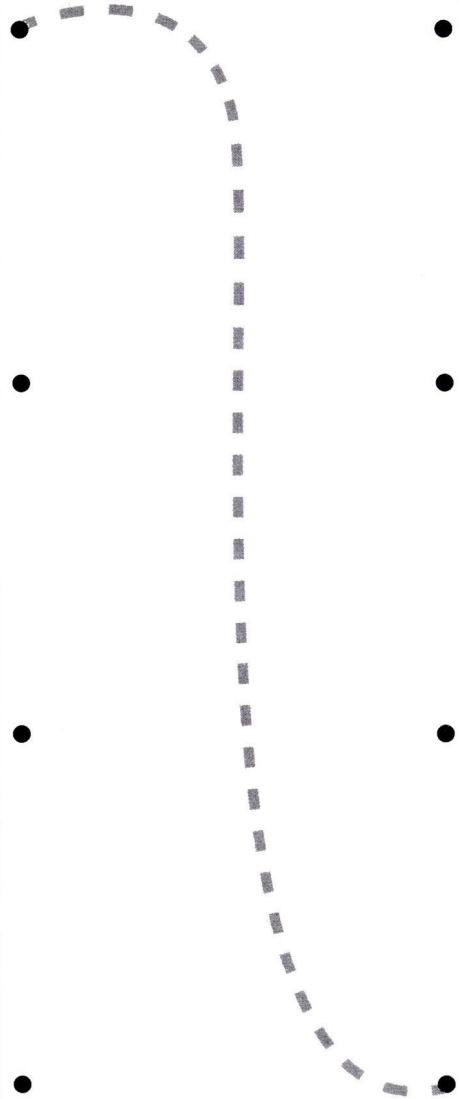
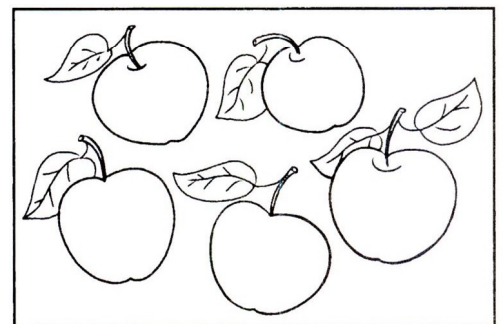
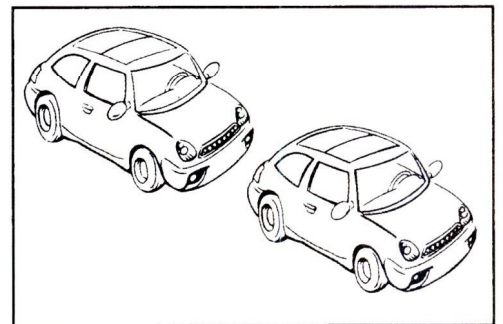
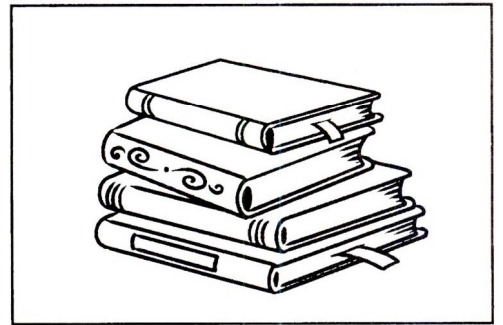
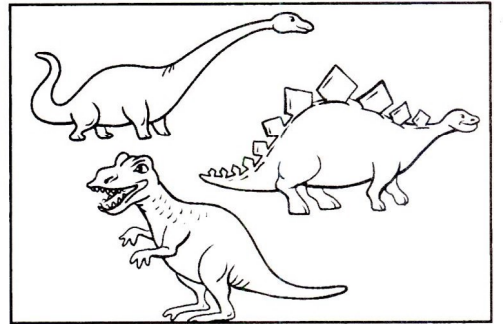
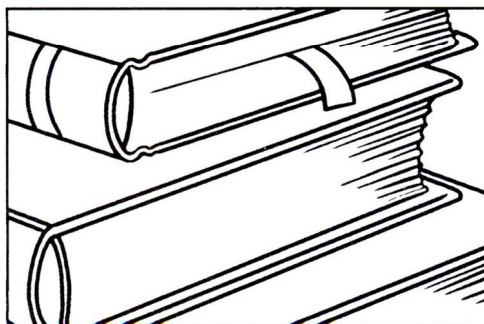
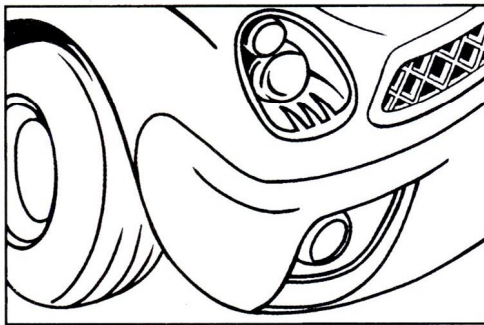
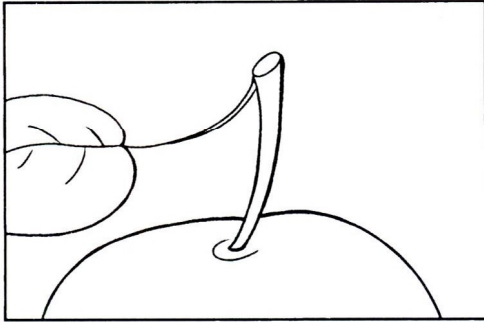

✓ Parent's signature: \_\_\_\_\_



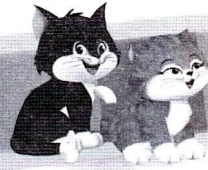

**A** Trace. Write.

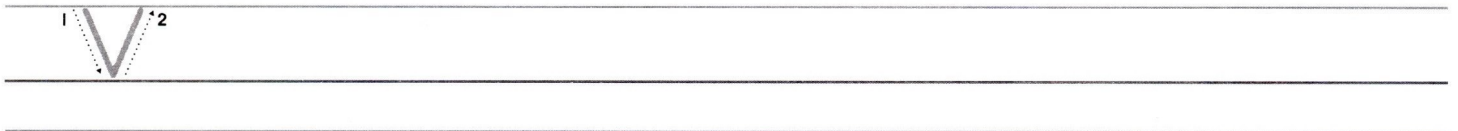
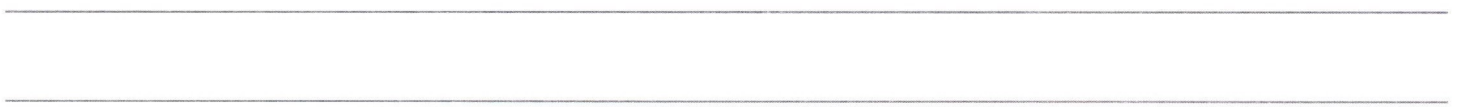
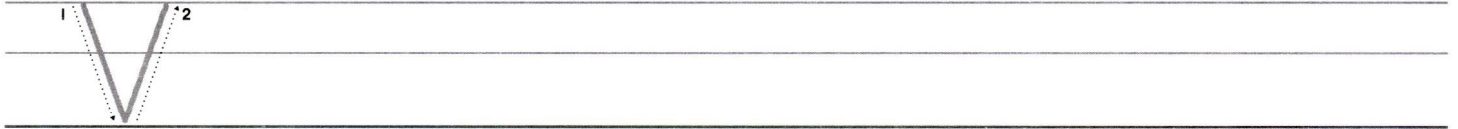

**B** Find. Color.

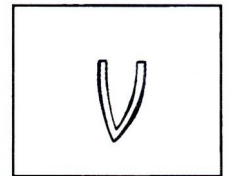
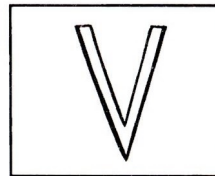
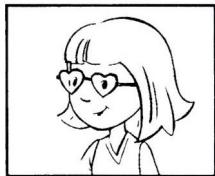
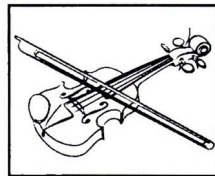
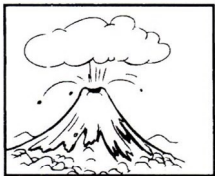

# Let's Talk

## C Color.

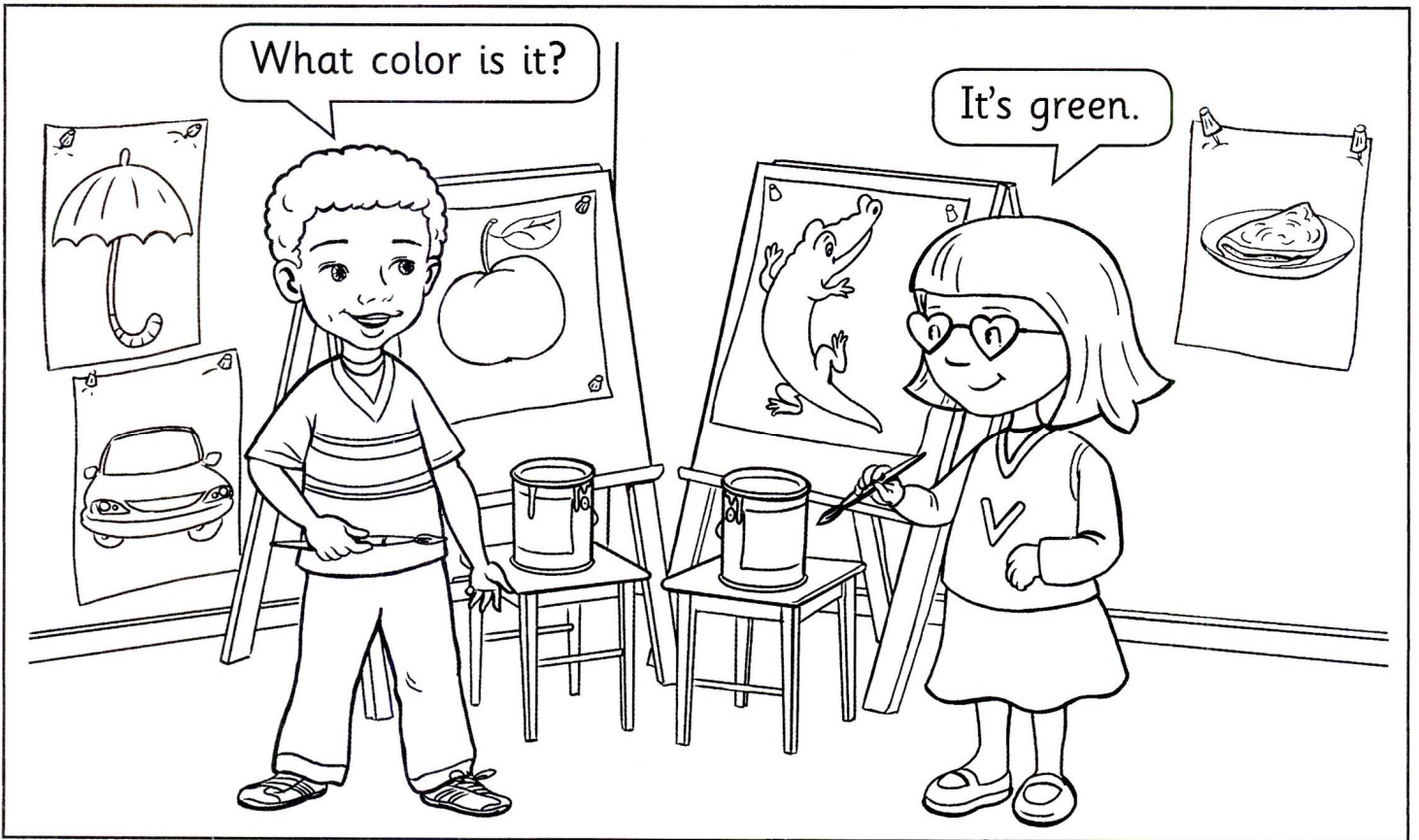

## D Color.

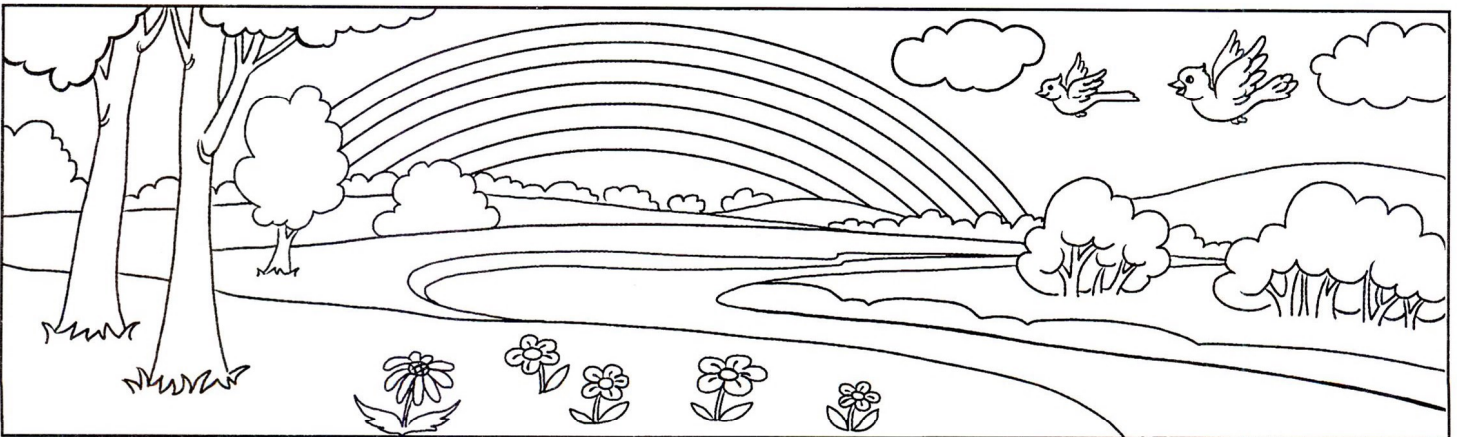

✓ Parent's signature: \_\_\_\_\_



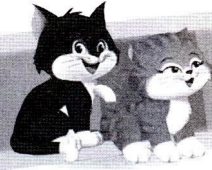

**A** Trace. Write.

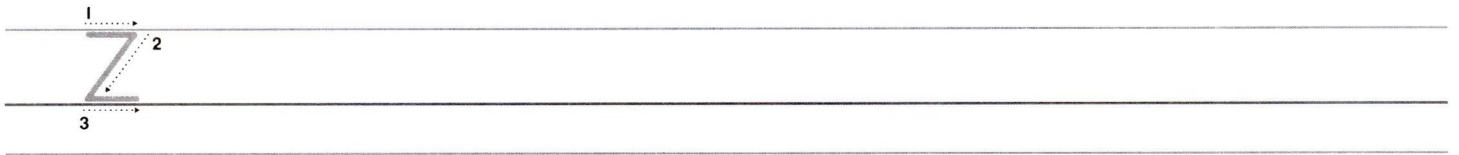
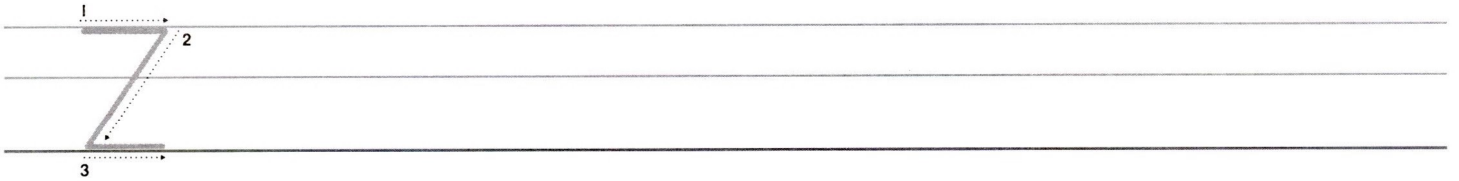

**B** Match. Color.

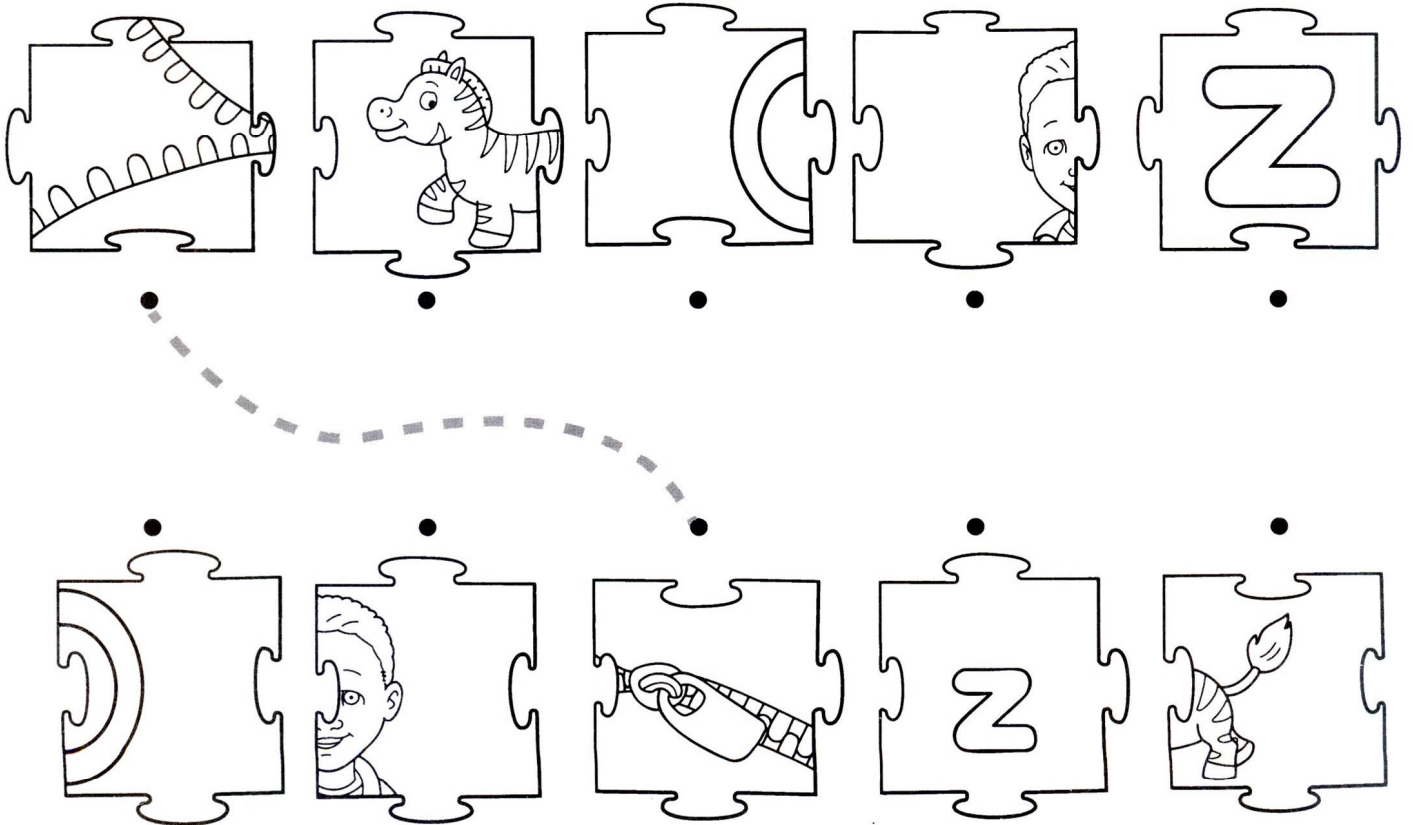

# Let's Talk

## C Color.

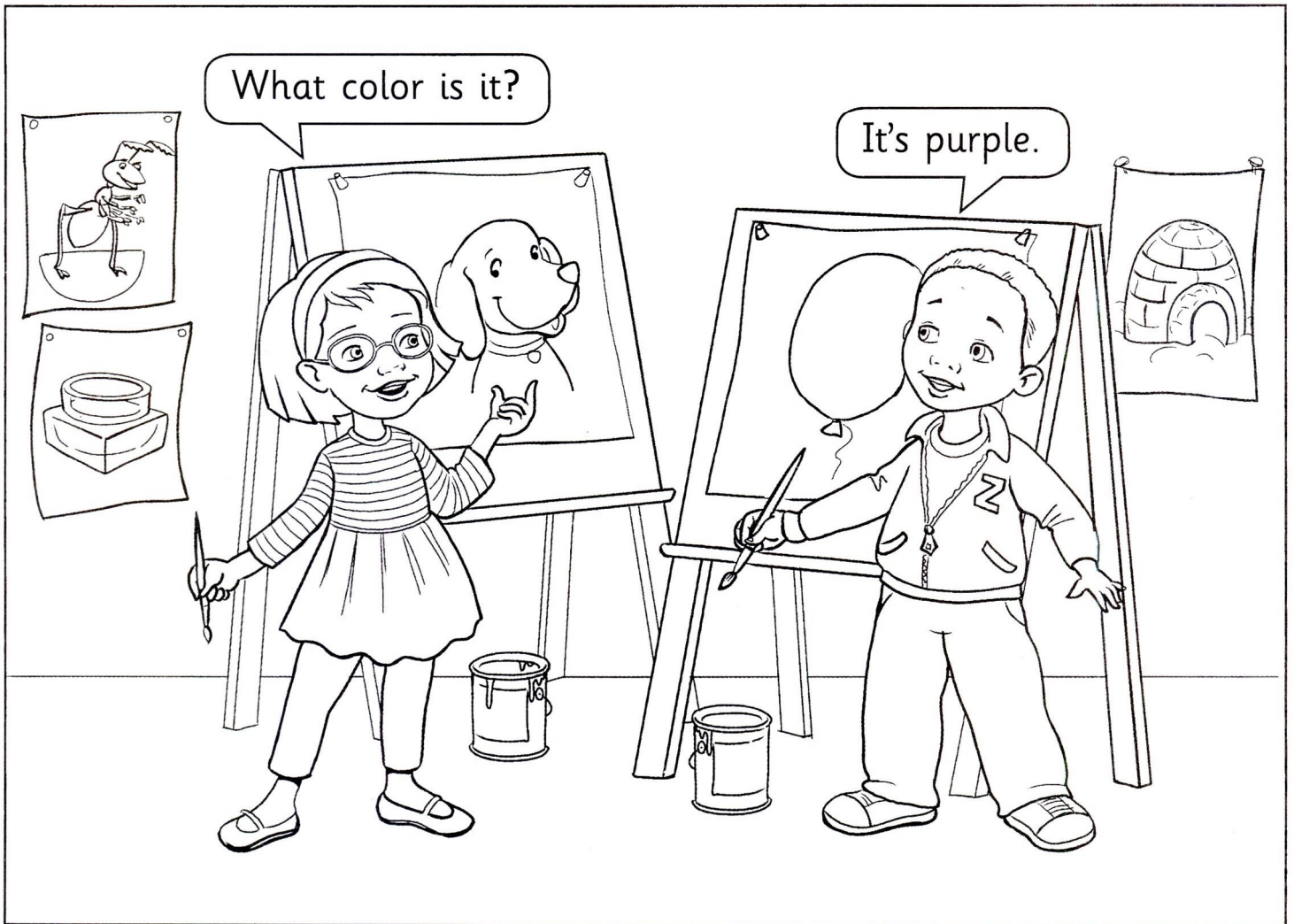

## D Color.

B C D G P T V Z

✓ Parent's signature: \_\_\_\_\_



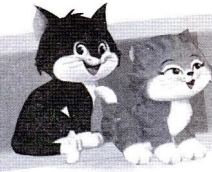

### A Trace. Write.

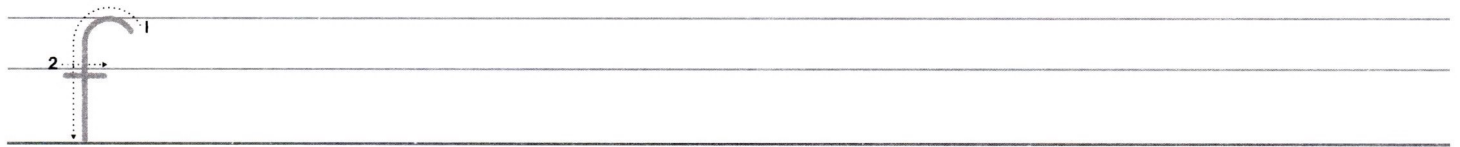
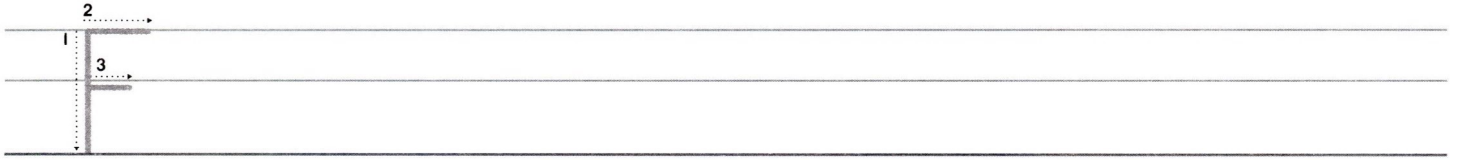

### B Follow. Trace. Color.

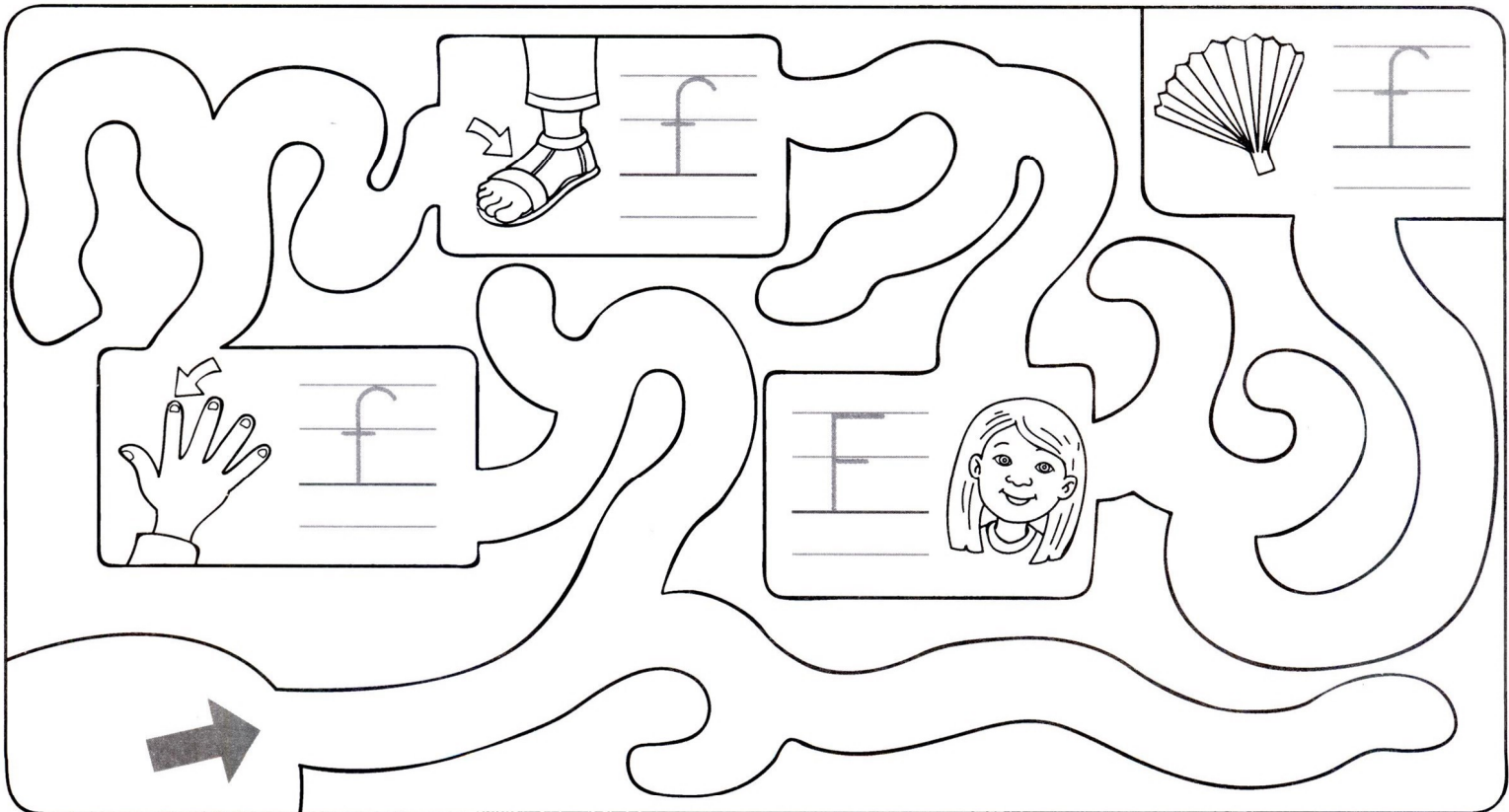

# Let's Talk

What shape is it?

It's a circle.

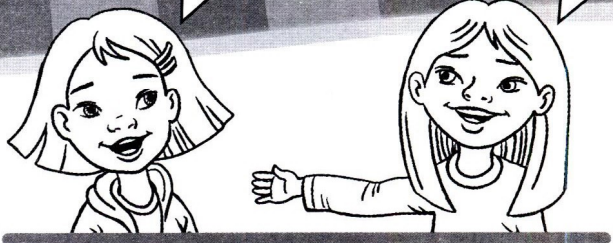

## C Match. Color.

•	•	•	•
•	•	•	•

## D Connect the numbers. Color.

--	--	--

✓ Parent's signature: \_\_\_\_\_





**A** Trace. Write.

Tracing practice lines for the letter 'L'. The first line shows a dashed 'L' with arrows and numbers 1 and 2 indicating stroke order: 1 for the vertical line down, 2 for the horizontal line to the right. Below this are two more sets of blank lines for independent writing practice.

**B** Circle the "l" pictures. Color.

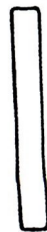
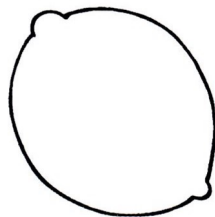

# Let's Talk

## Count. Write. Color.

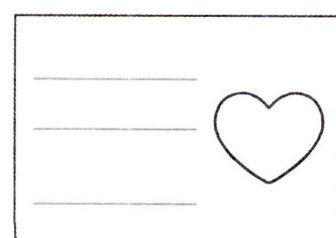
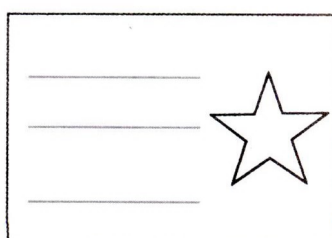
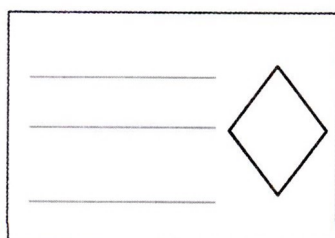
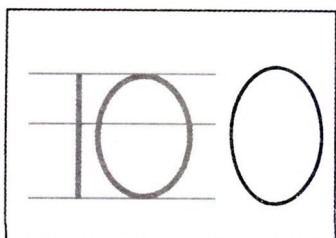
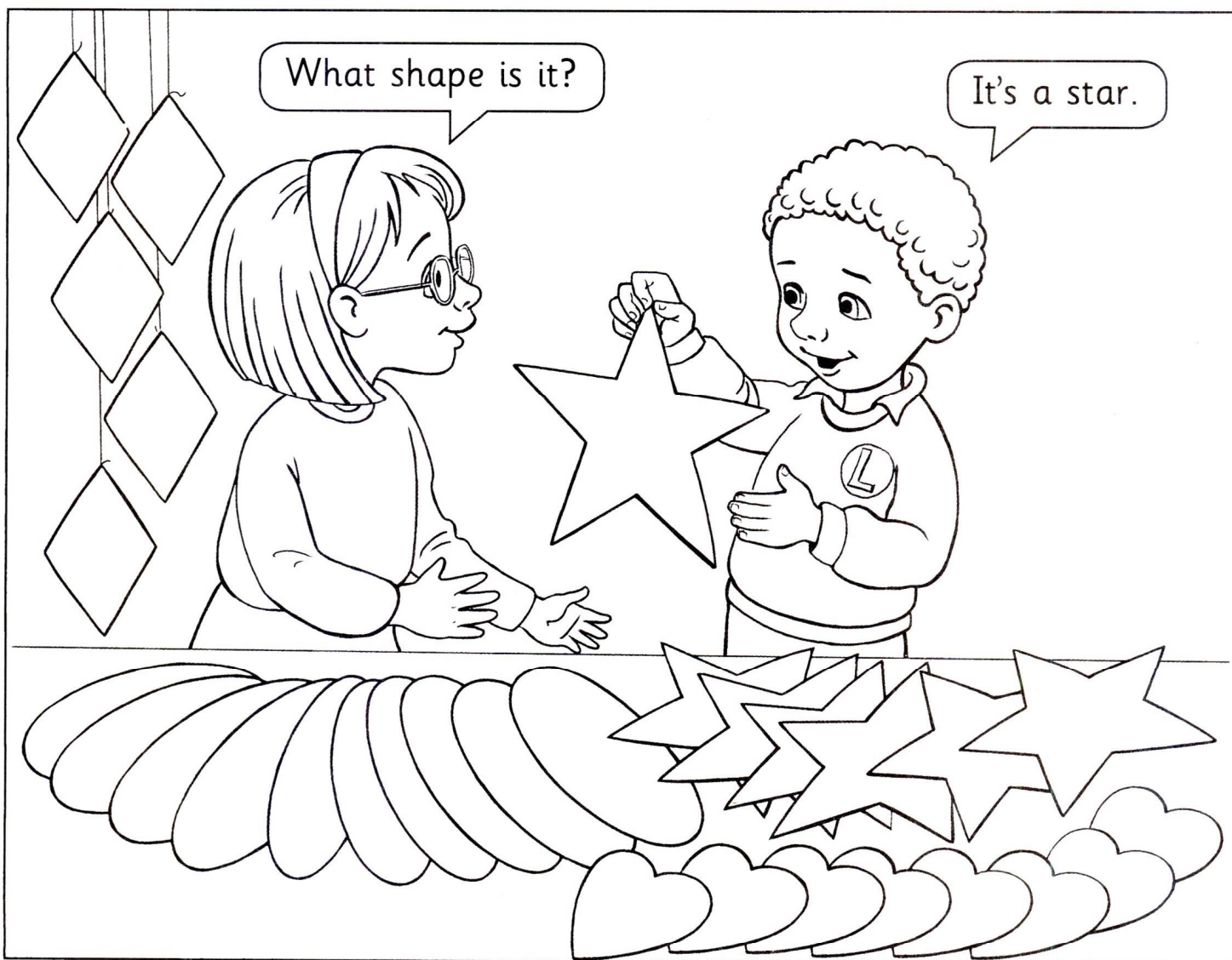

✓ Parent's signature: \_\_\_\_\_



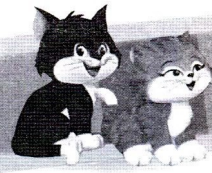

### A Trace. Write.

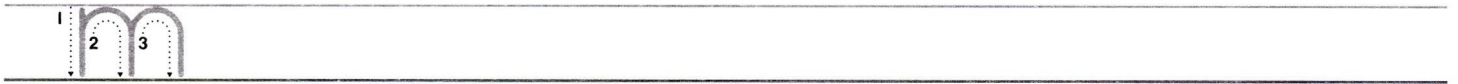
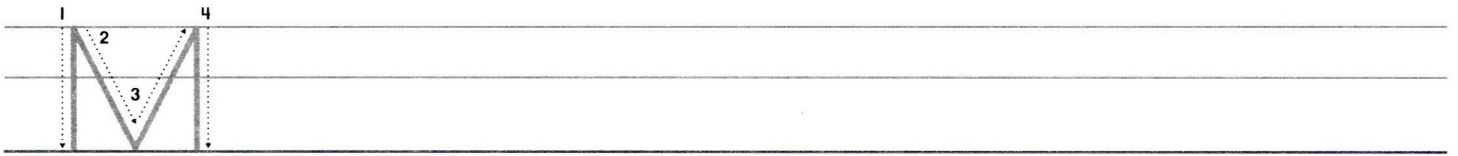

### B Connect. Trace. Color.

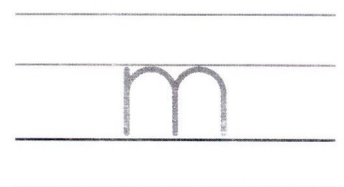
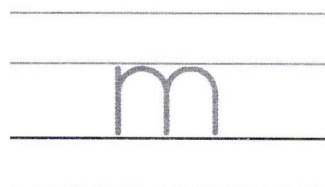
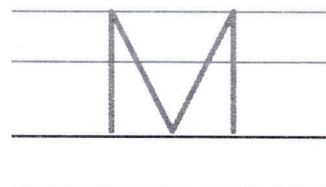
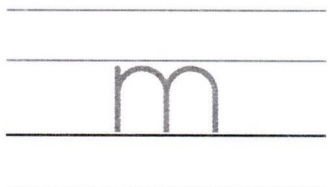
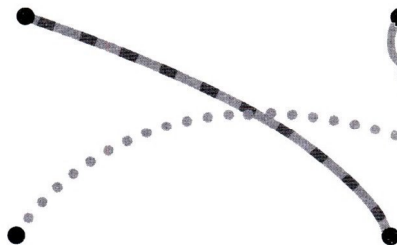
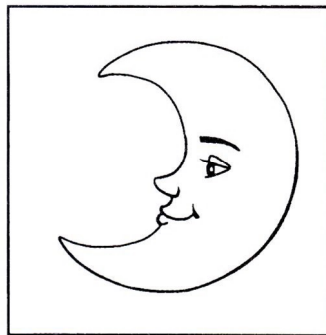
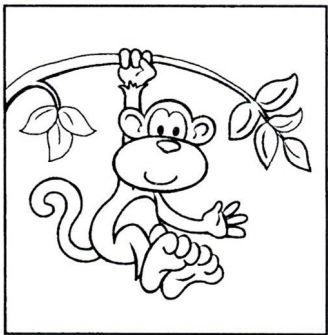

# Let's Talk

## C Color.



## D Match. Color.

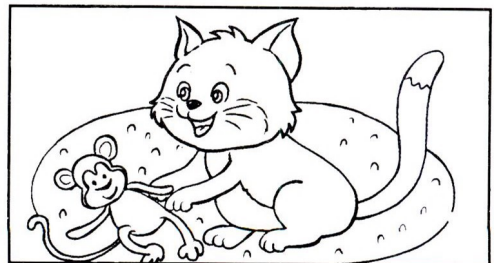
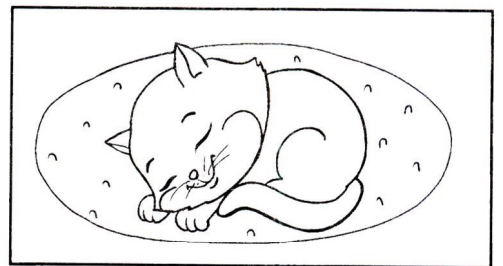
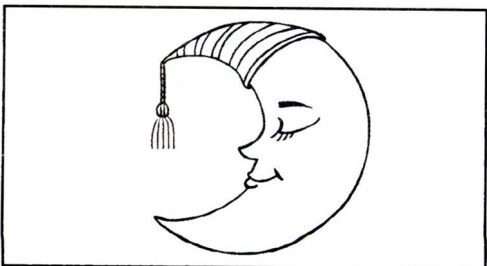

✓ Parent's signature: \_\_\_\_\_



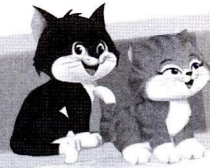

### A Trace. Write.

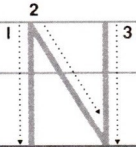

### B Find. Color.

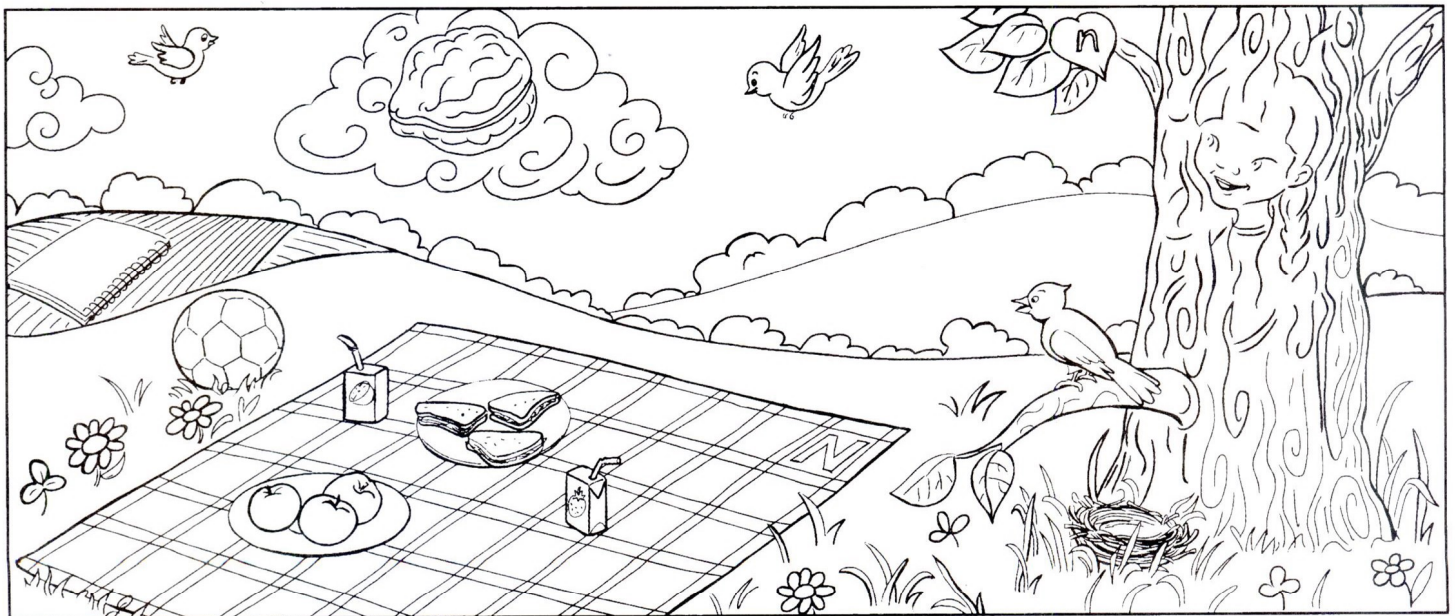
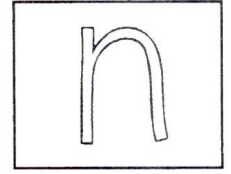
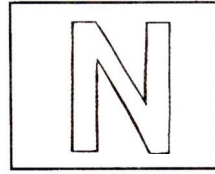
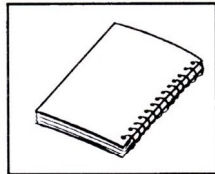
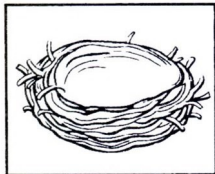
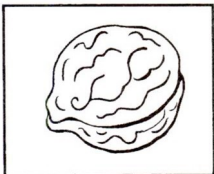

# Let's Talk

## © Match. Trace. Color.

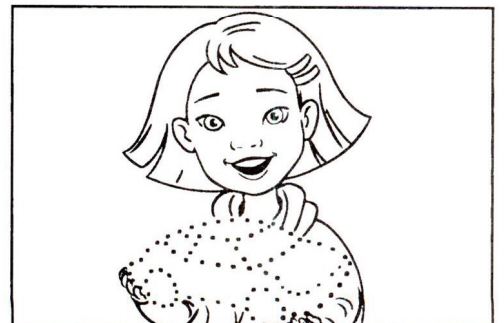
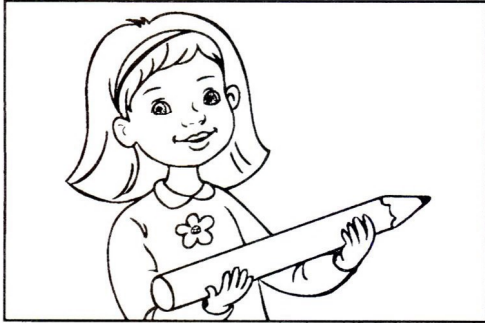

✓ Parent's signature: \_\_\_\_\_



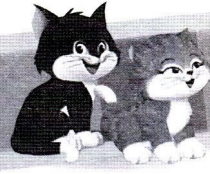

**A** Trace. Write.



**B** Circle the "s" pictures. Color.

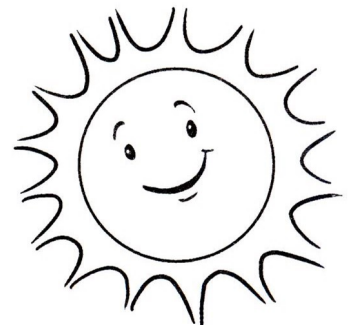
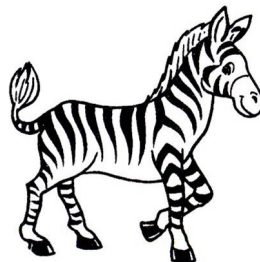
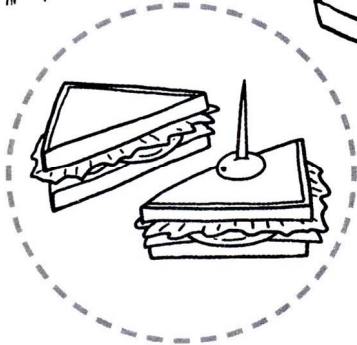
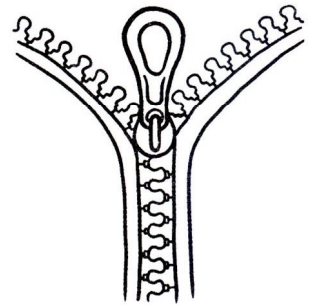
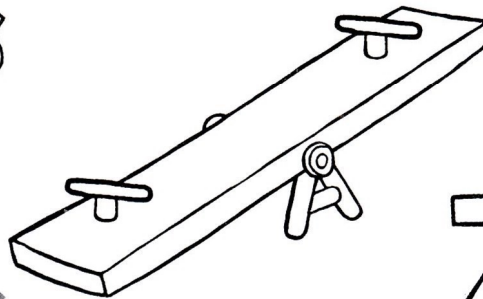

# Let's Talk

## © Trace. Color.

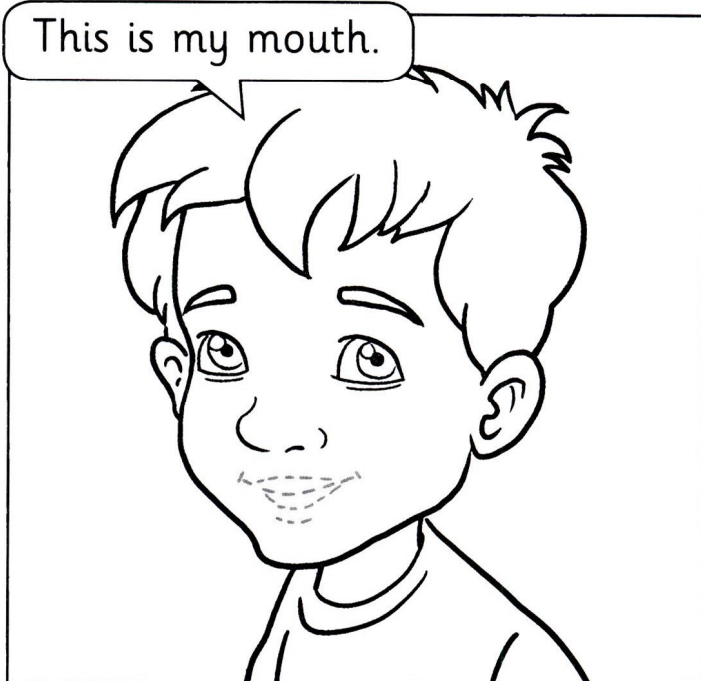
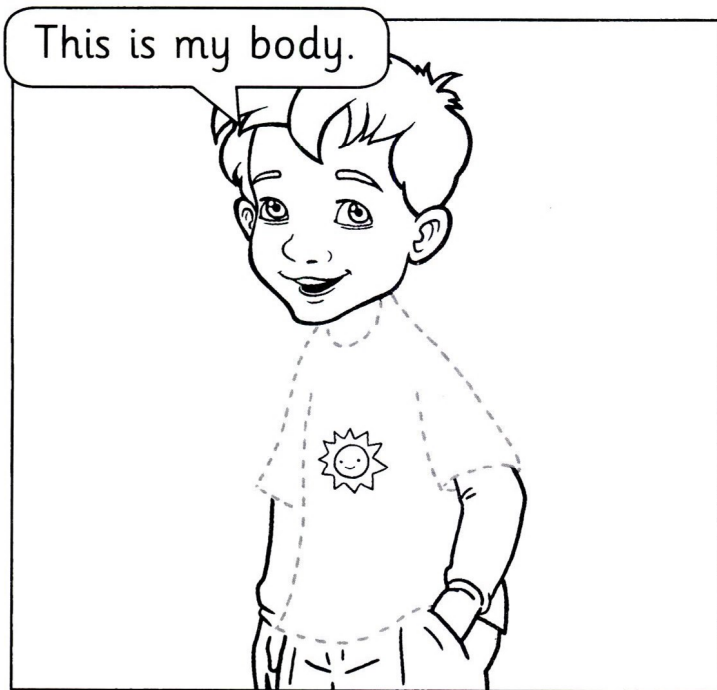



Lesson 19

Xx

Let's Learn

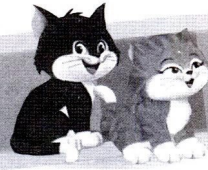

**A** Trace. Write.

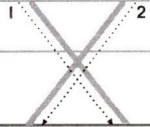

**B** Match. Color.

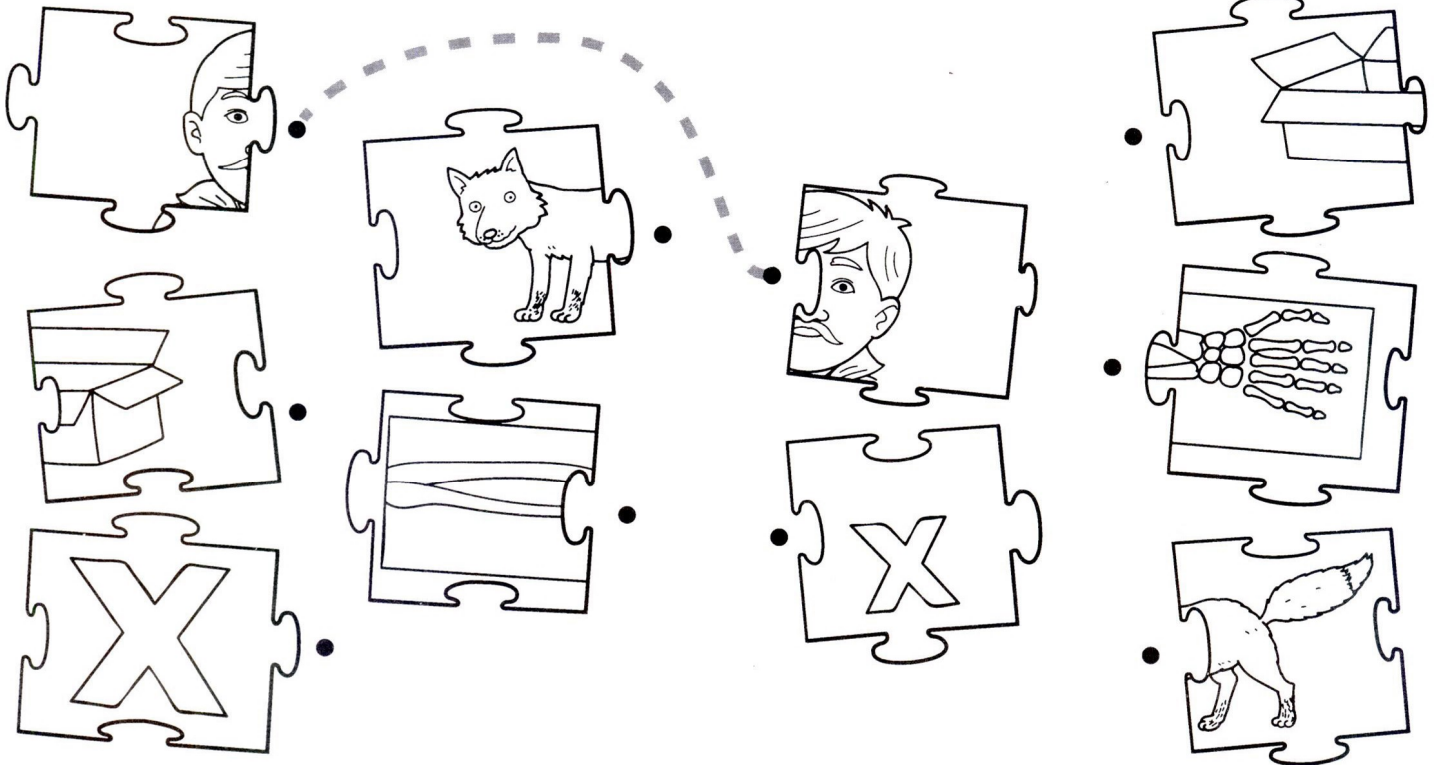

# Let's Talk

## C Color.

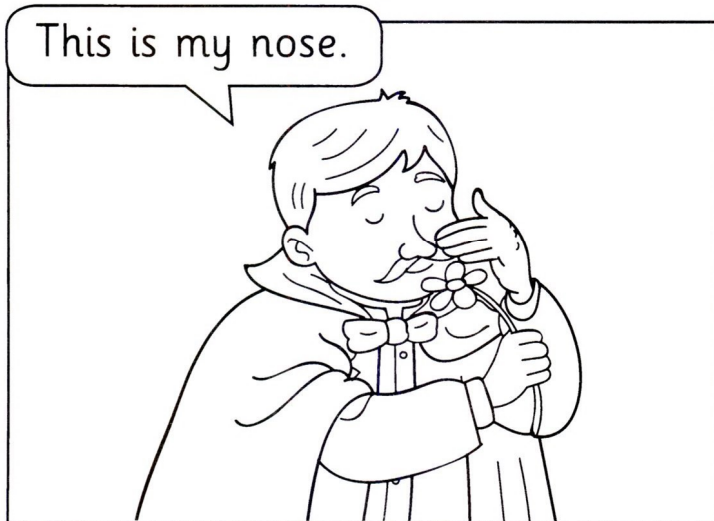
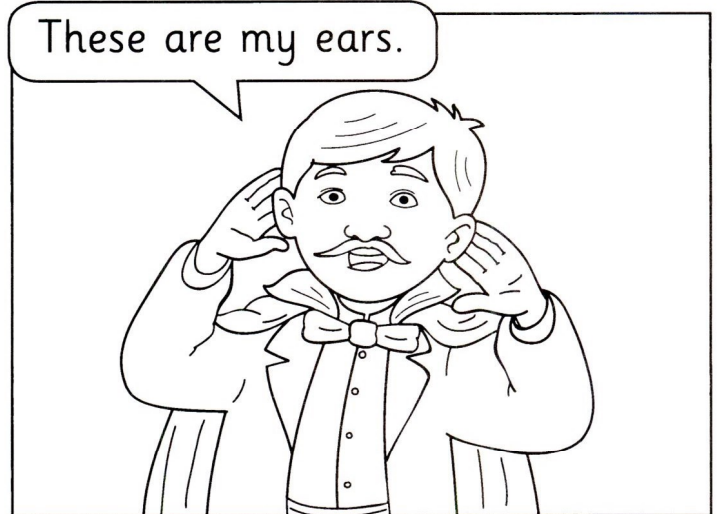

## D Color.

S L M N F X

✓ Parent's signature: \_\_\_\_\_



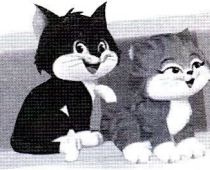

**A** Trace. Write.

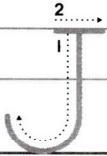

**B** Follow. Trace. Color.

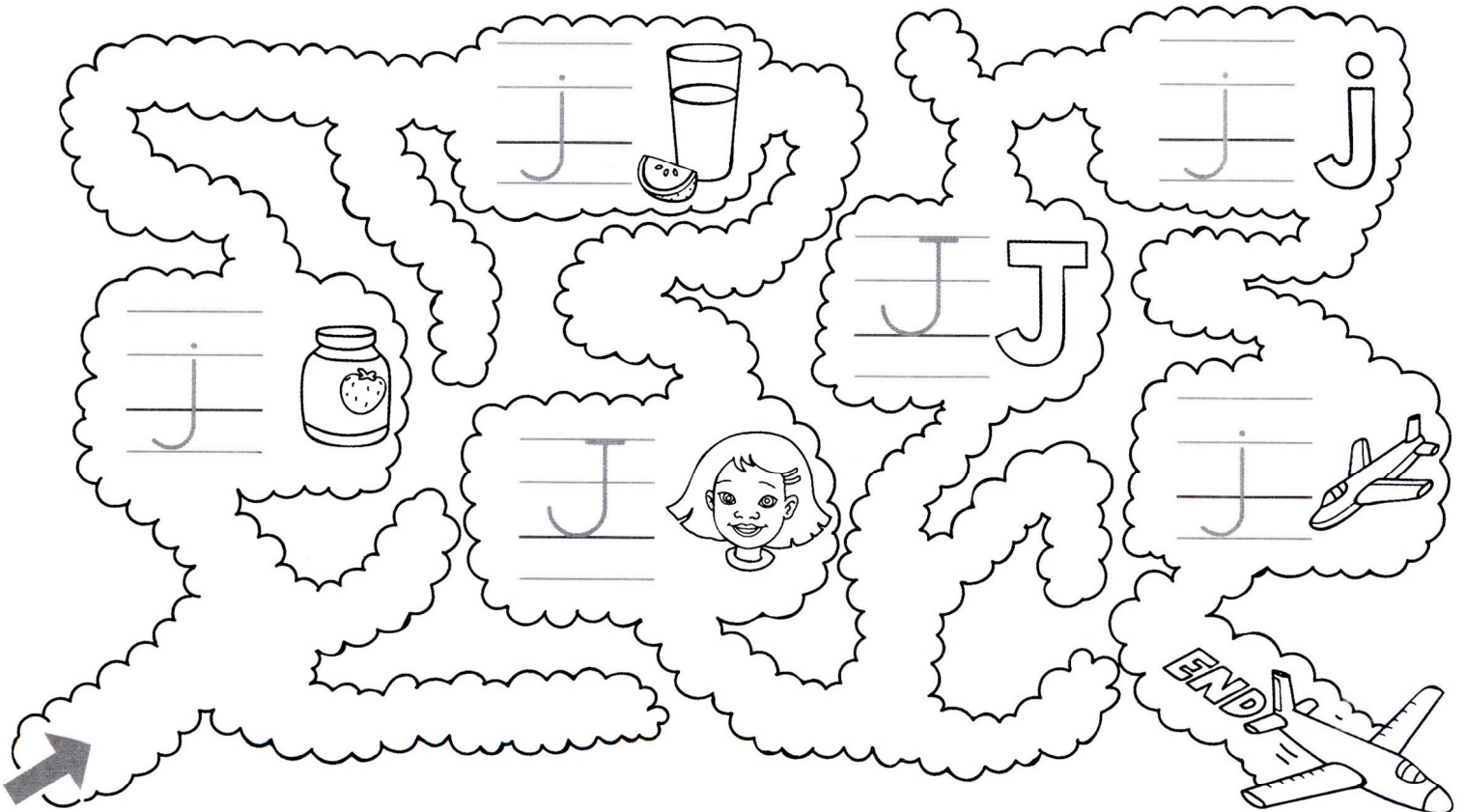

# Let's Talk

These are my hands.



## Color.

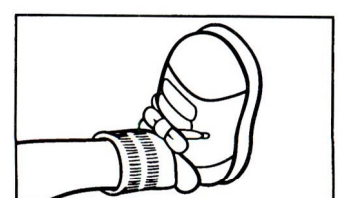
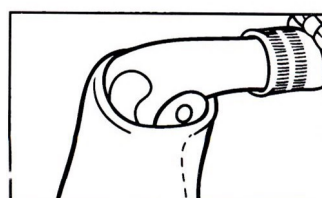
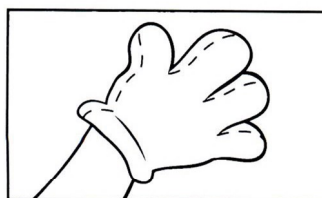
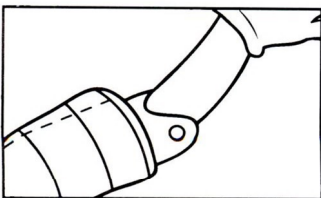
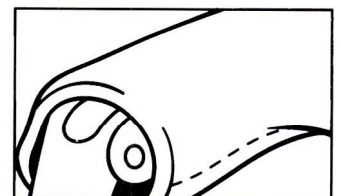
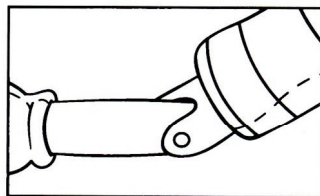
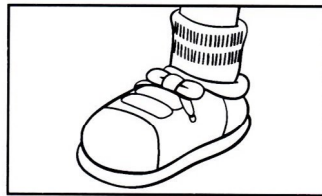
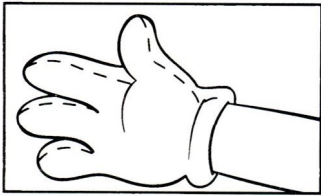

✓ Parent's signature: \_\_\_\_\_





**A** Trace. Write.

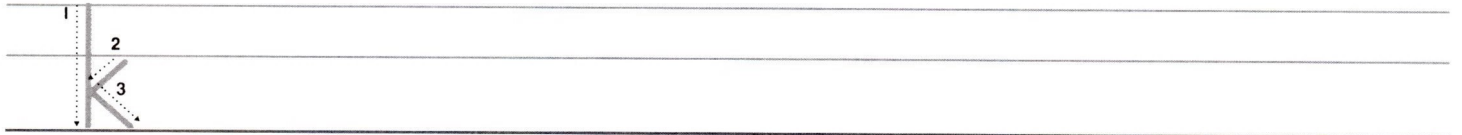
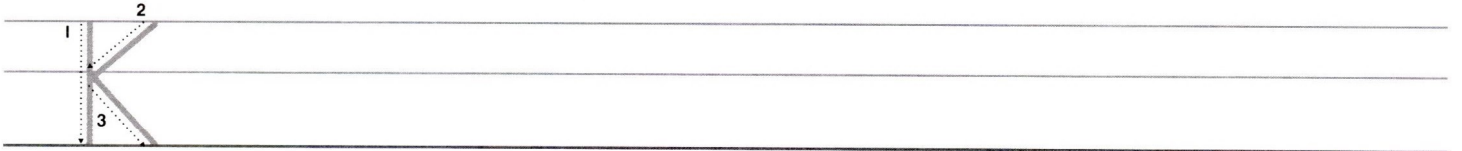

**B** Connect. Trace. Color.

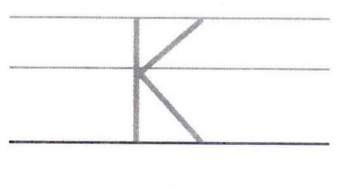
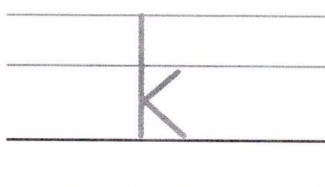
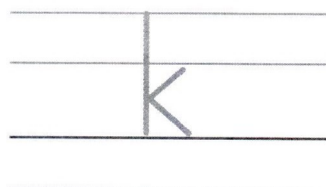
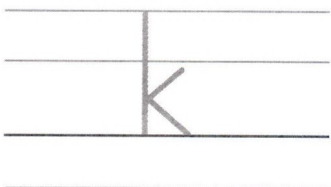
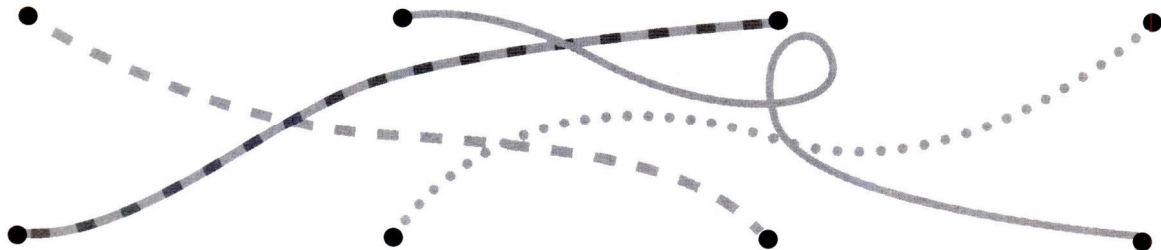
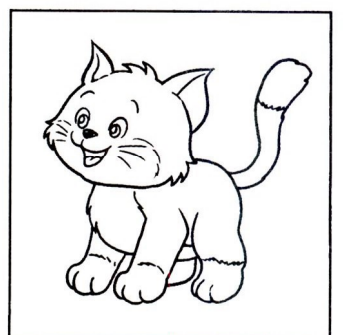
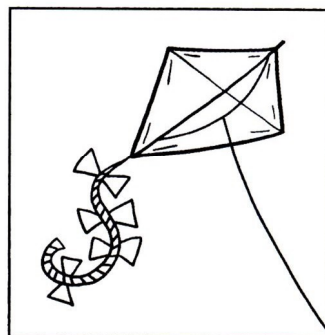
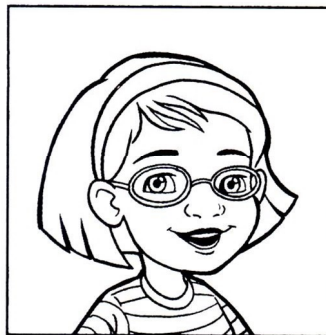
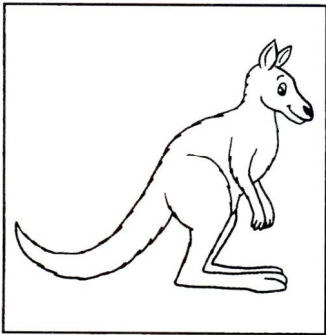

# Let's Talk

**C** Trace your hand. Color.



**D** Color.

J K

✓ Parent's signature: \_\_\_\_\_



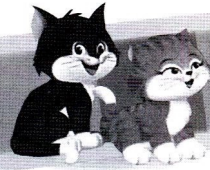

### A Trace. Write.

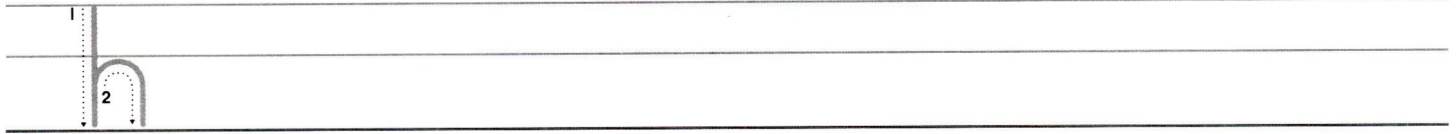
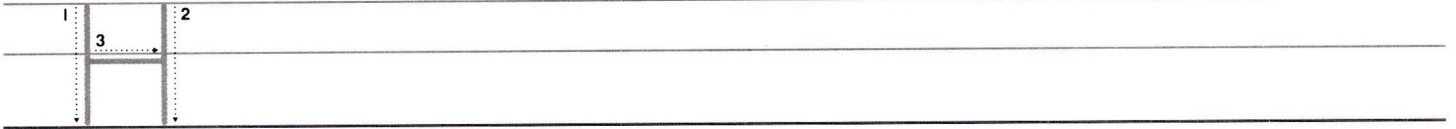

### B Match. Color.

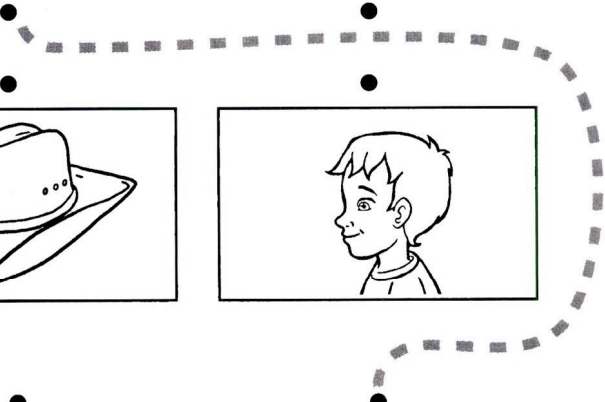
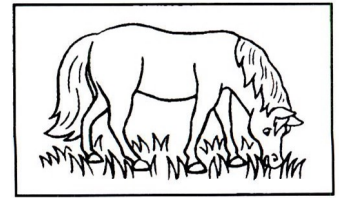
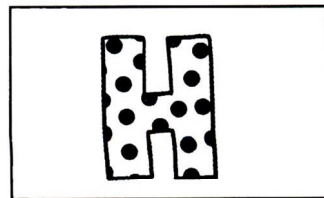
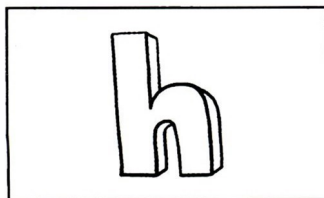
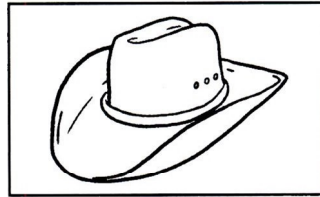
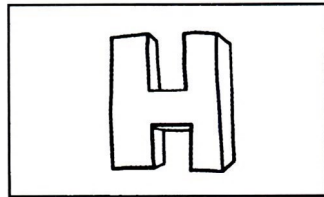
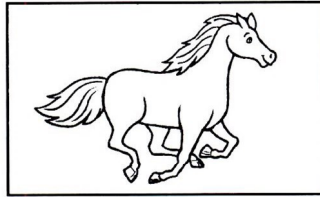
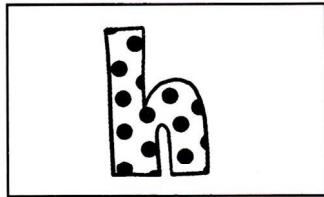
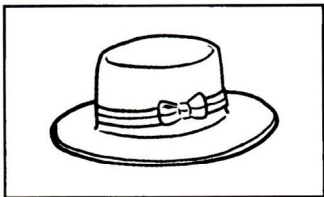

# Let's Talk

## Follow the insect. Color.

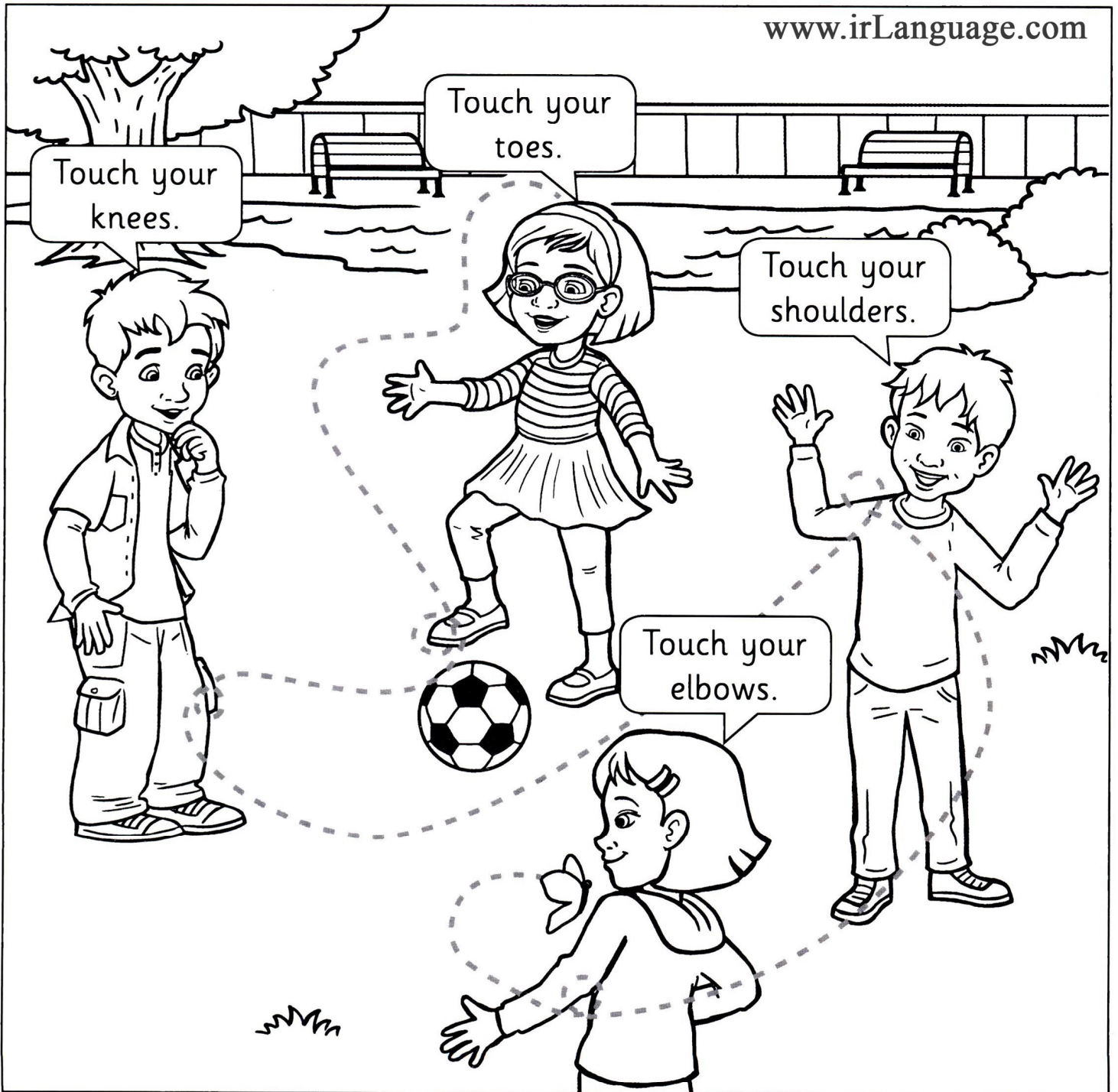

✓ Parent's signature \_\_\_\_\_





**A** Trace. Write.

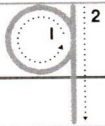
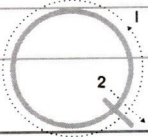

**B** Find. Color.

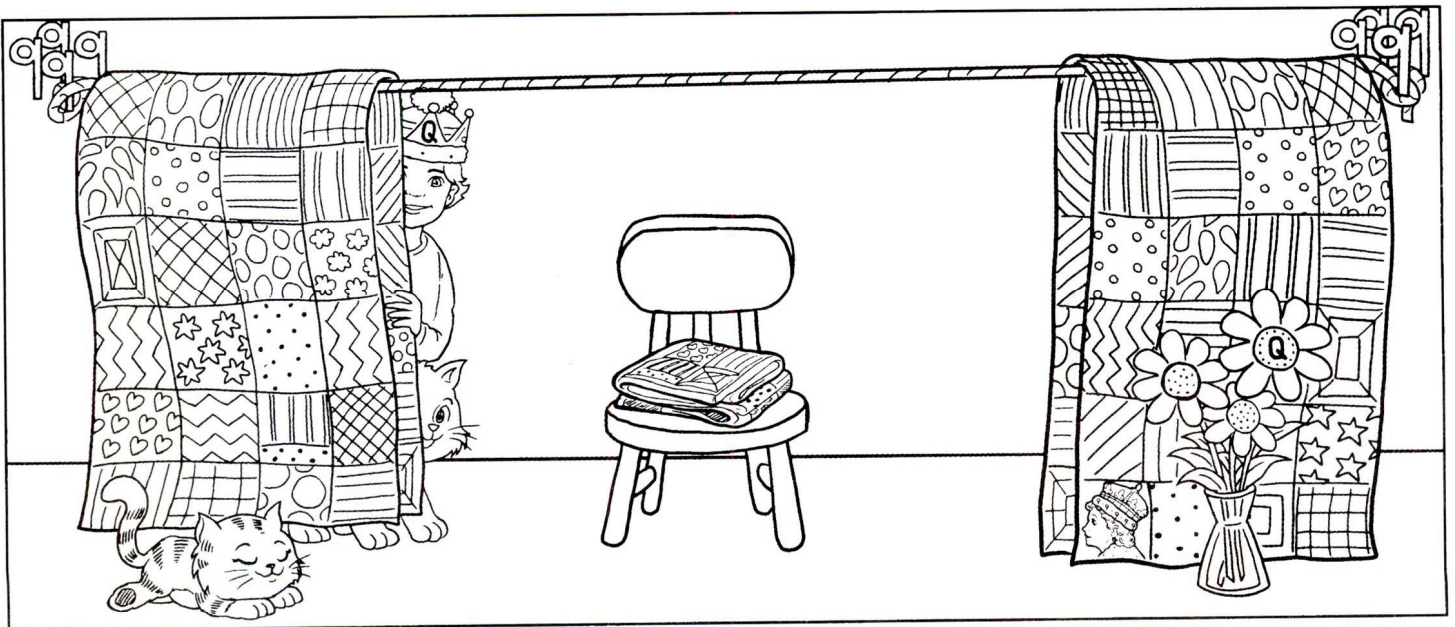
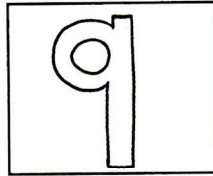
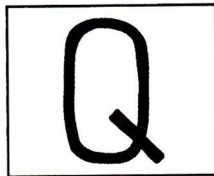
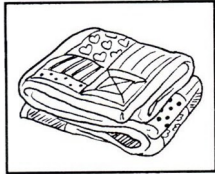

# Let's Talk

## C Color.

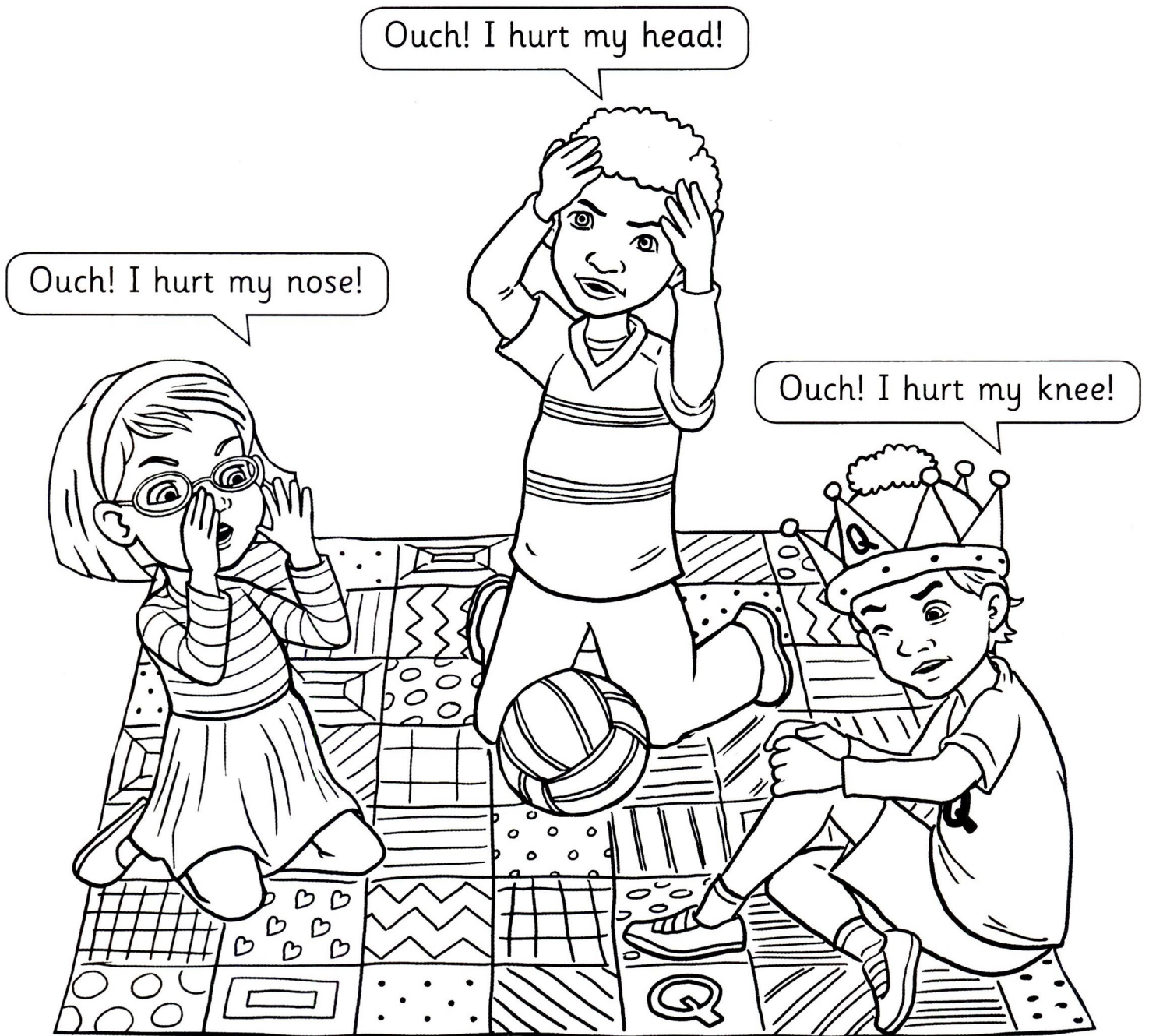



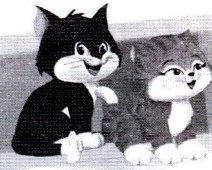

**A** Trace. Write.

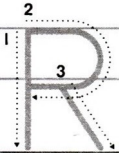

**B** Circle the "r" pictures. Color.

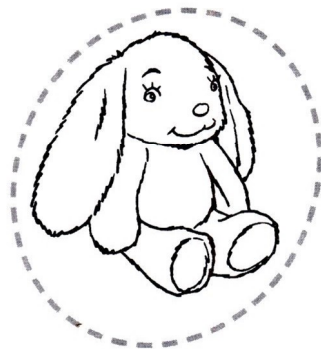
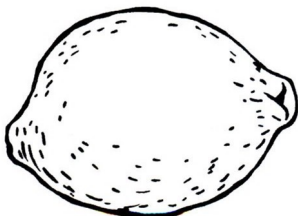
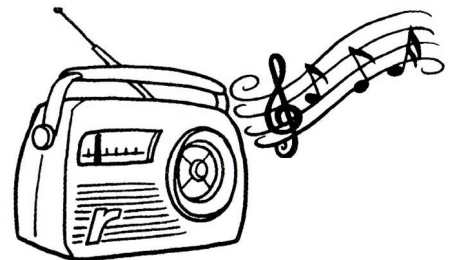
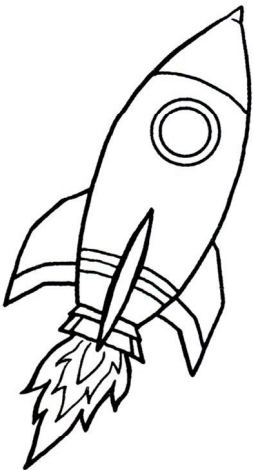

R

r

# Let's Talk

## C Match. Color.

www.irLanguage.com

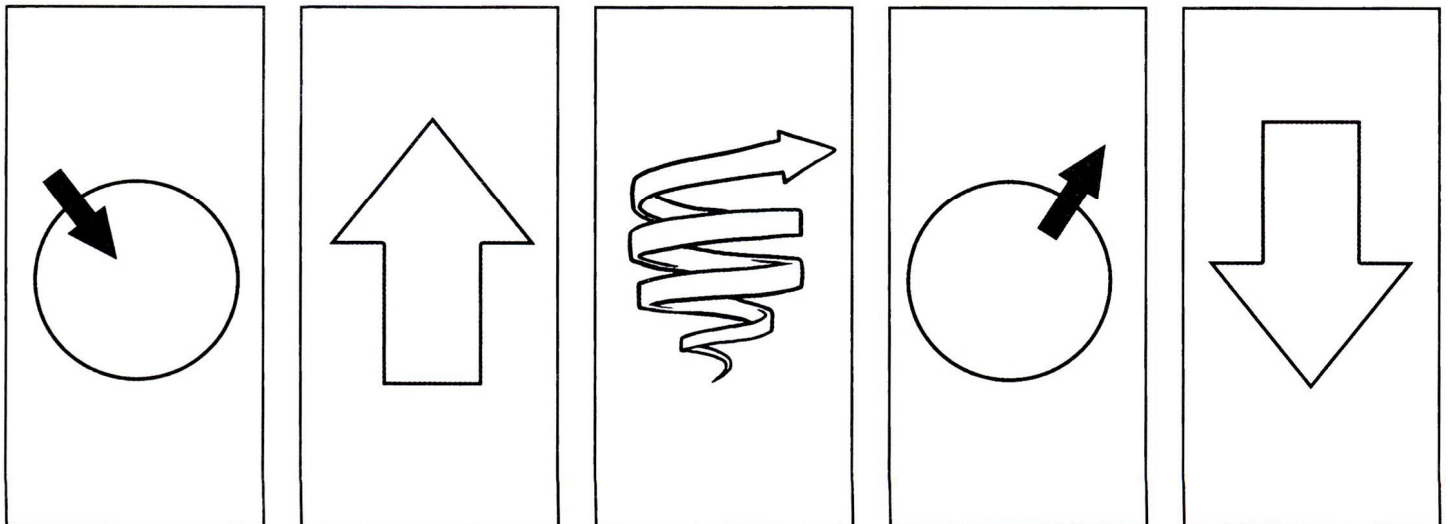
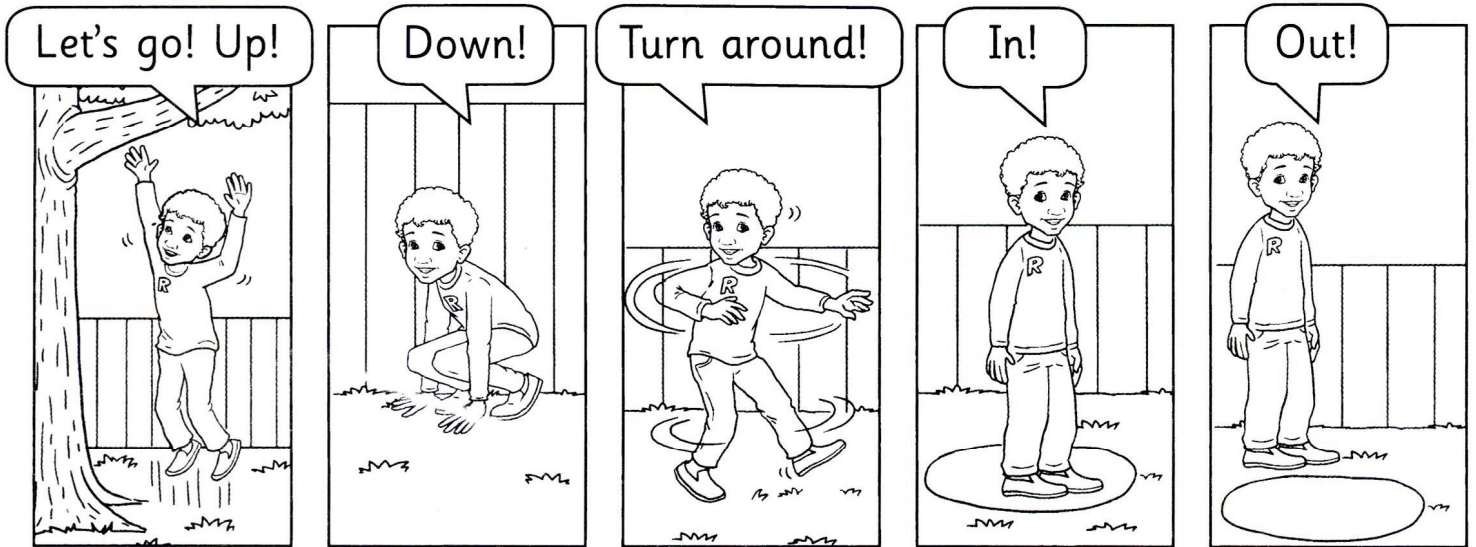

✓ Parent's signature: \_\_\_\_\_





**A** Trace. Write.

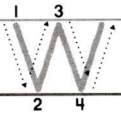
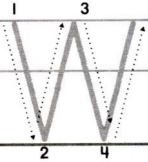

**B** Connect. Trace. Color.

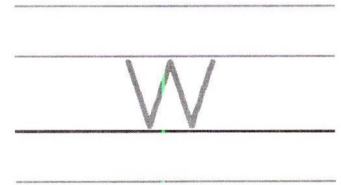
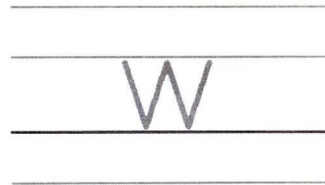
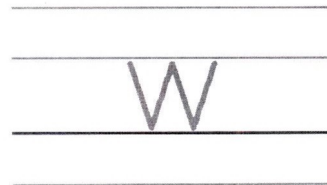
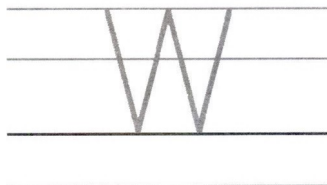
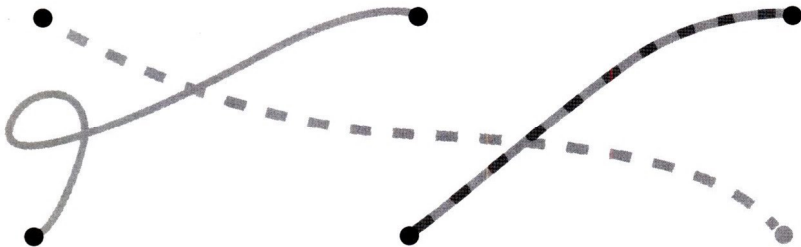
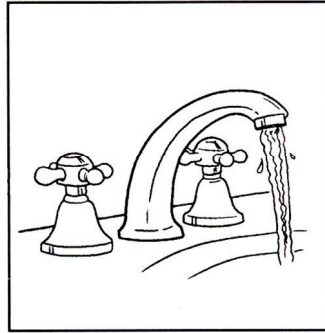
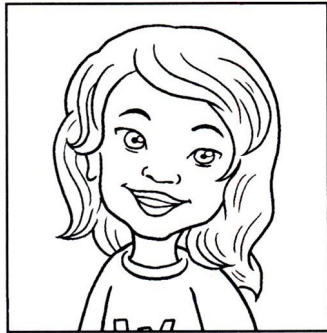

# Let's Talk

## Match. Color.

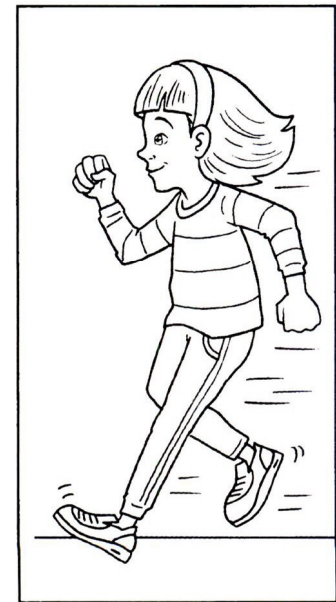
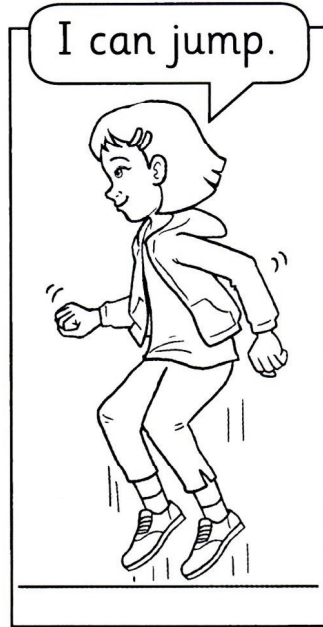
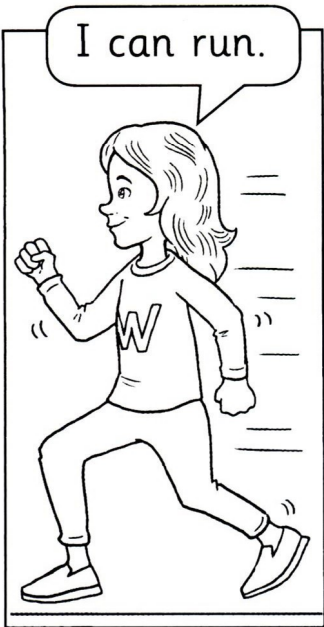

✓ Parent's signature: \_\_\_\_\_





**A** Trace. Write.

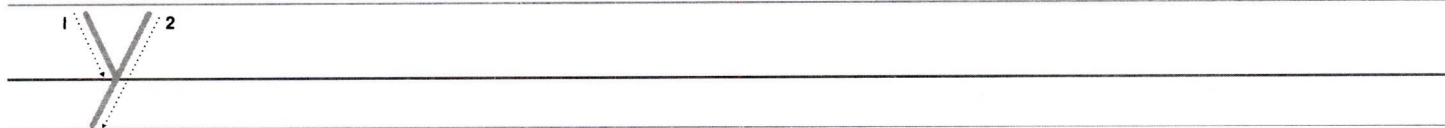
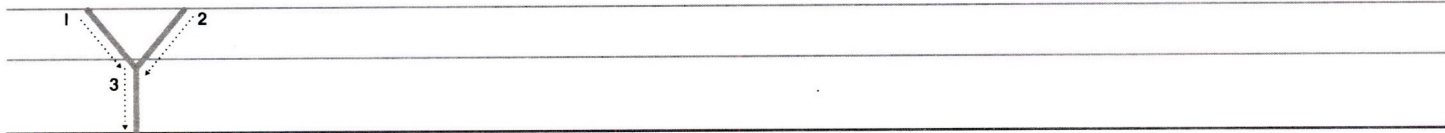

**B** Match. Color.

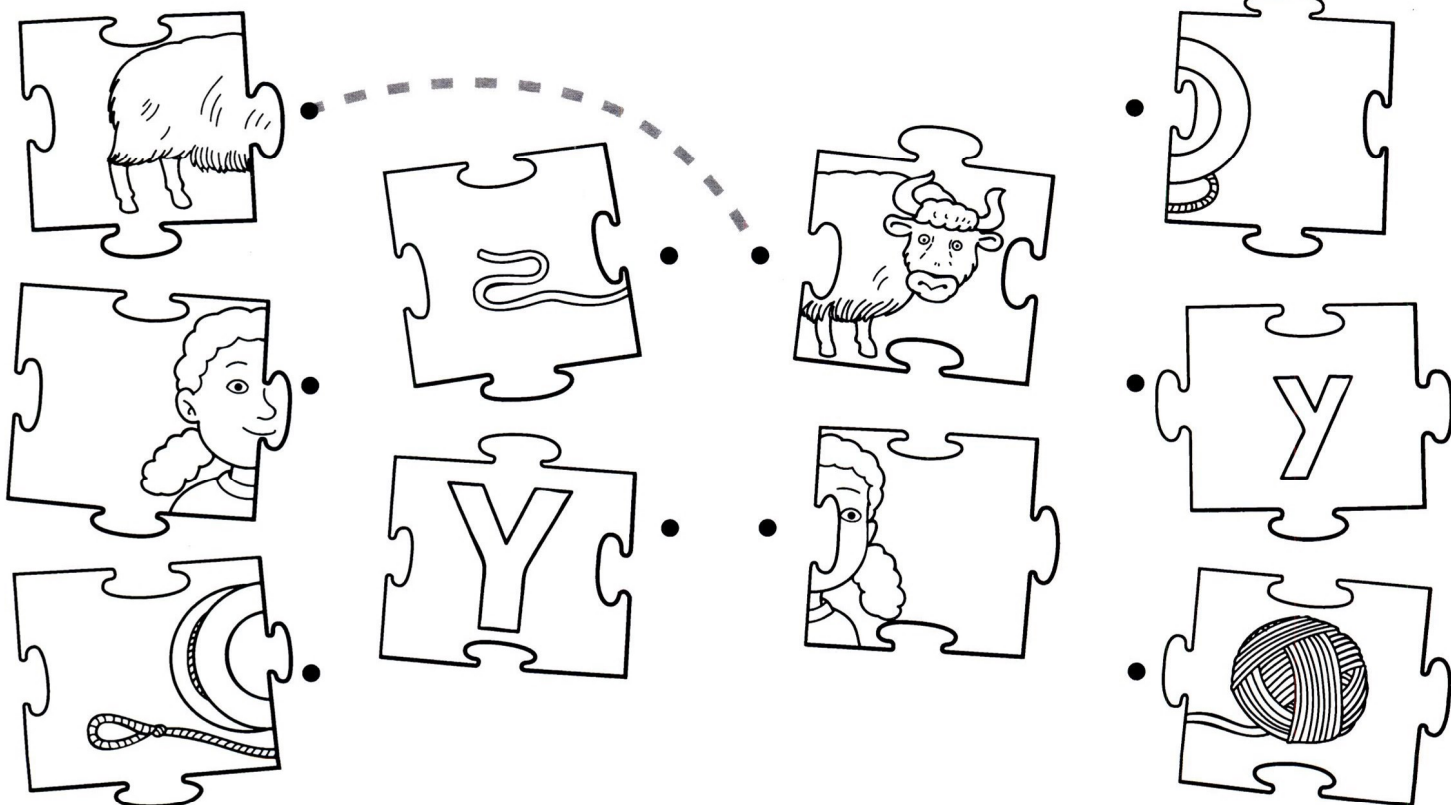

# Let's Talk

## C Color.



## D Color.

H Q R W Y

✓ Parent's signature: \_\_\_\_\_



Lesson 27  
The  
Alphabet

Let's Learn

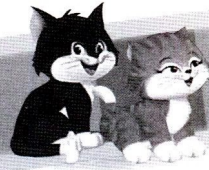

**A** Trace.

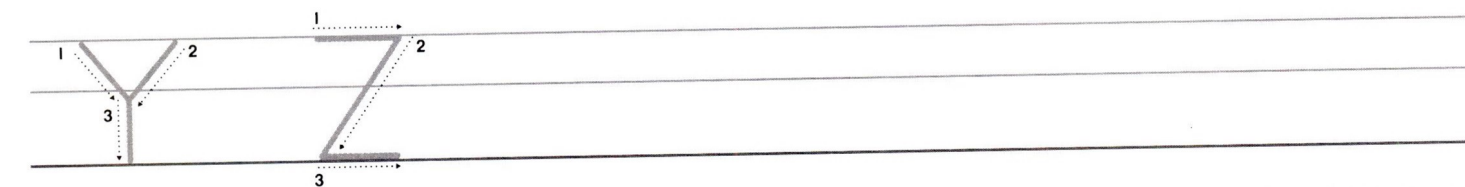
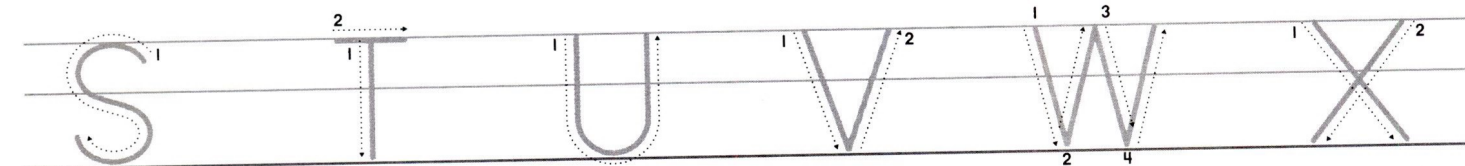
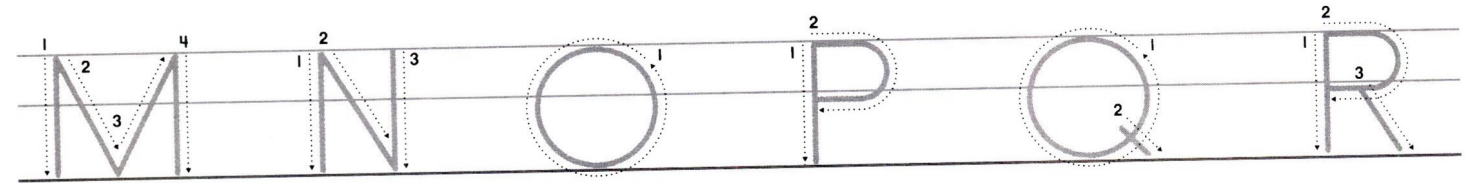
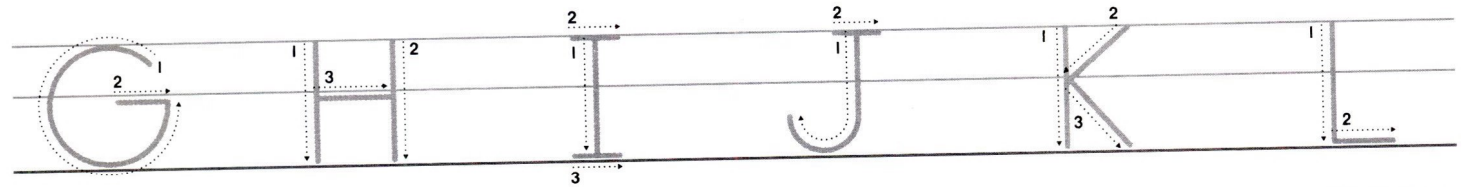
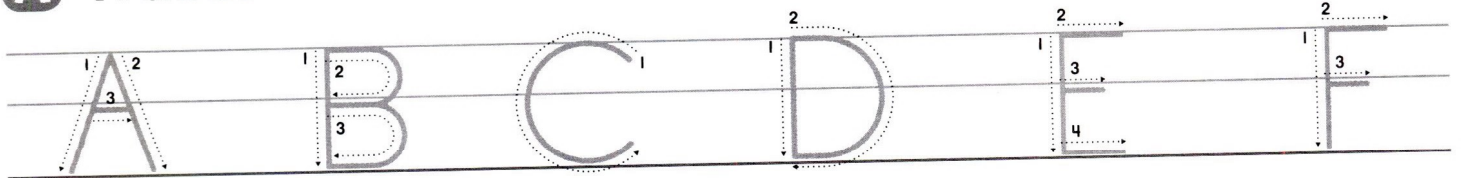

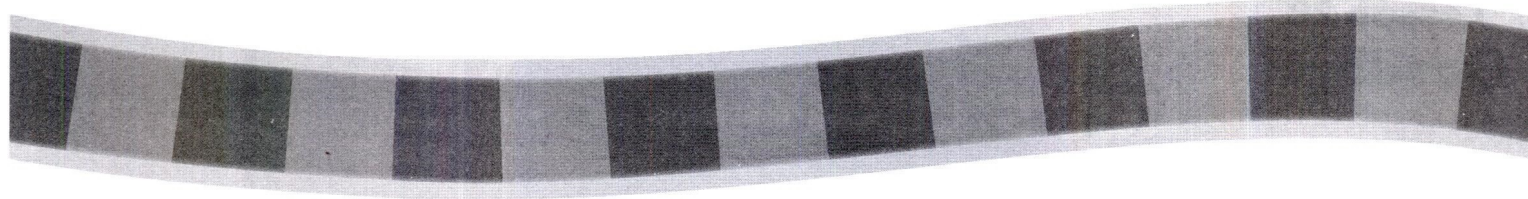

## B Trace.

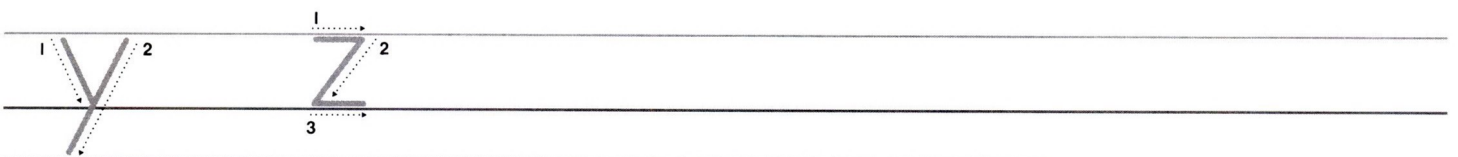
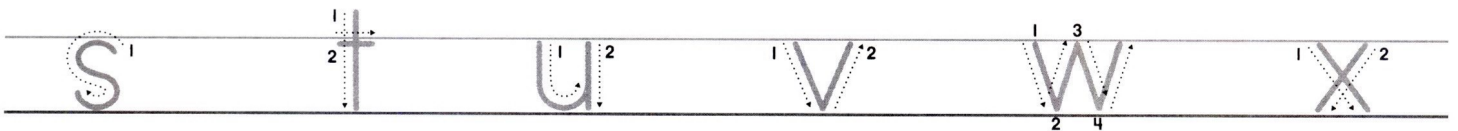
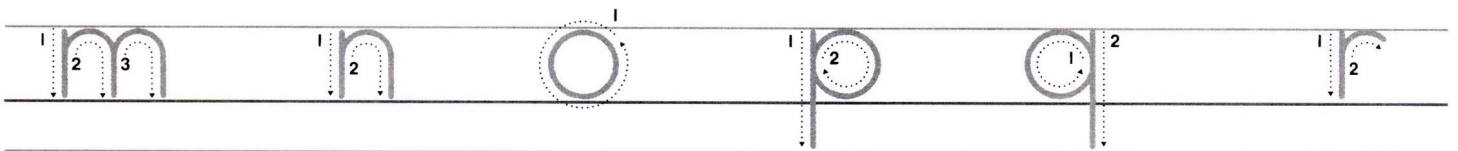
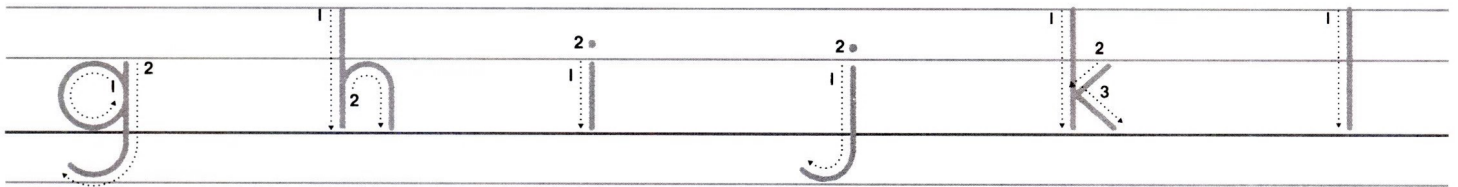
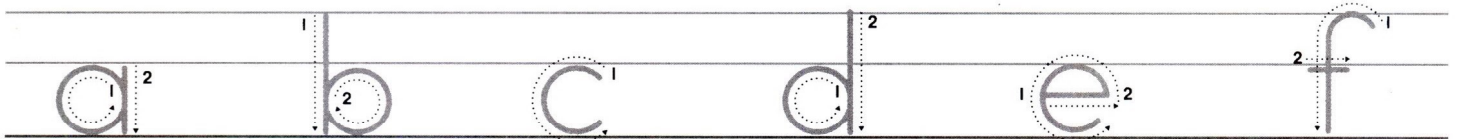

✓ Parent's signature: \_\_\_\_\_





**A** Connect the letters and numbers. Color.

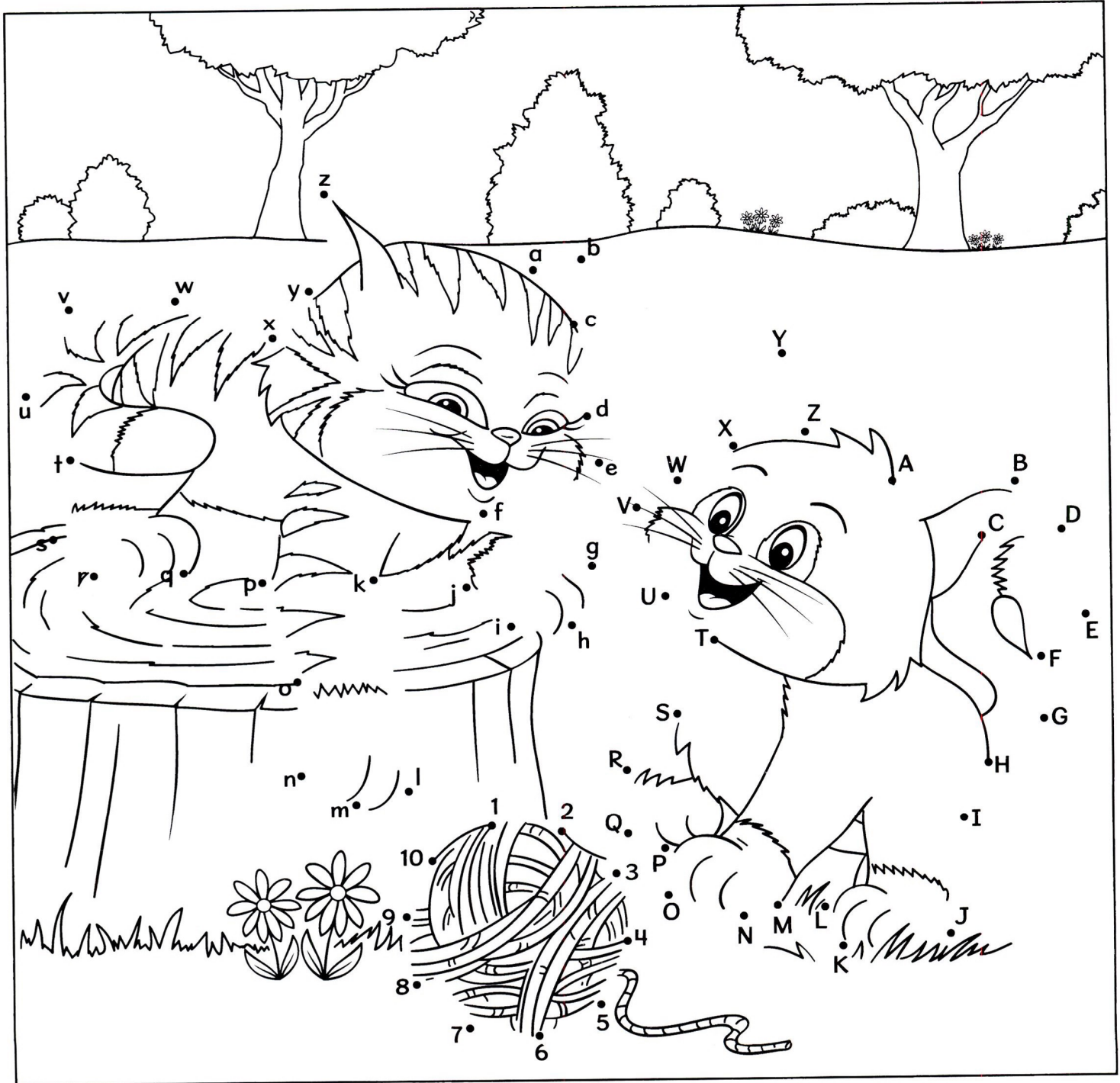

# Let's Talk

## B Color.

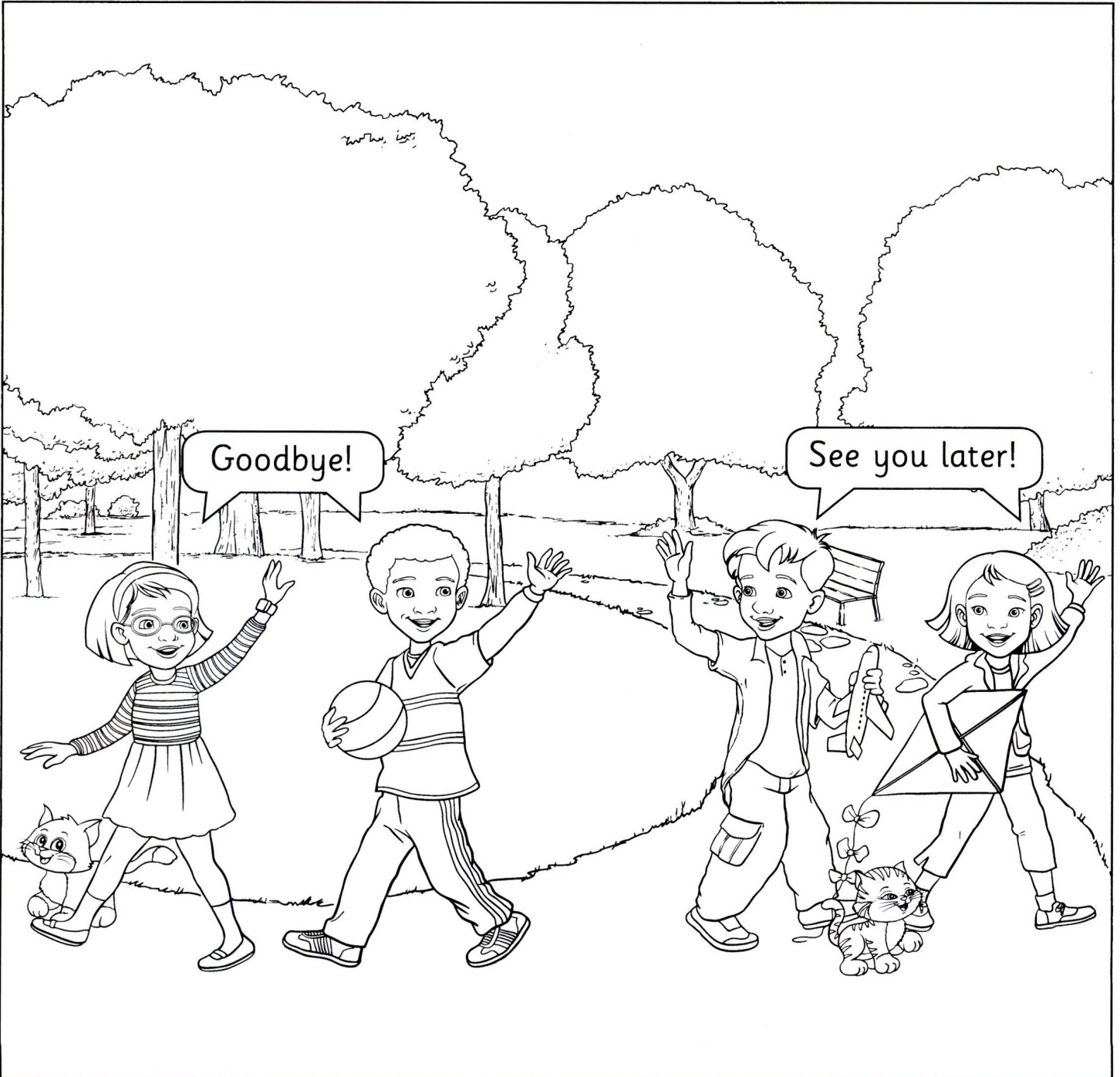

✓ Parent's signature: \_\_\_\_\_





## The Vowels

### A Color. Trace.

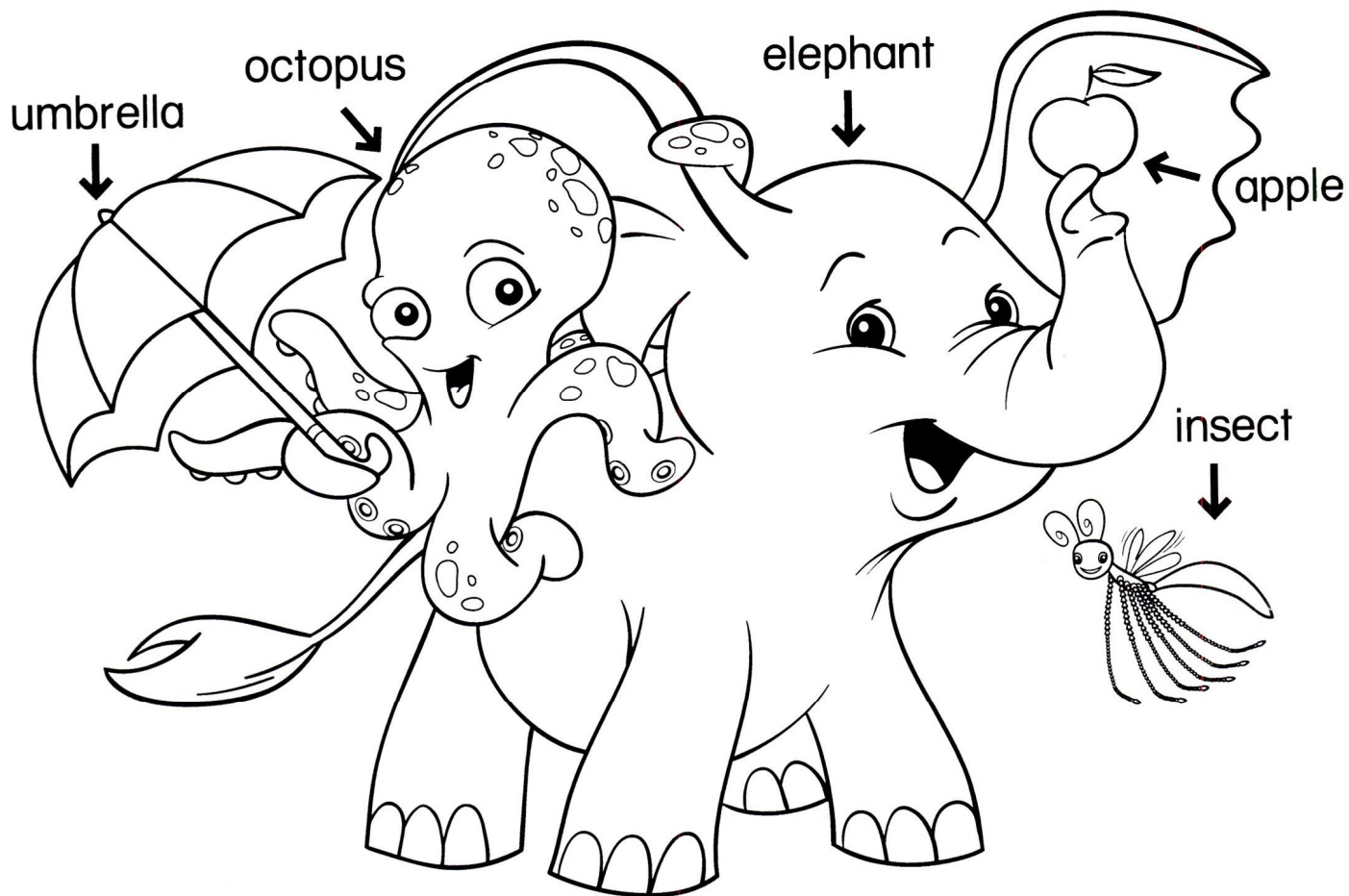

Aa

Ee

Ii

Oo

Uu

# The EE Group

## B Color. Trace.

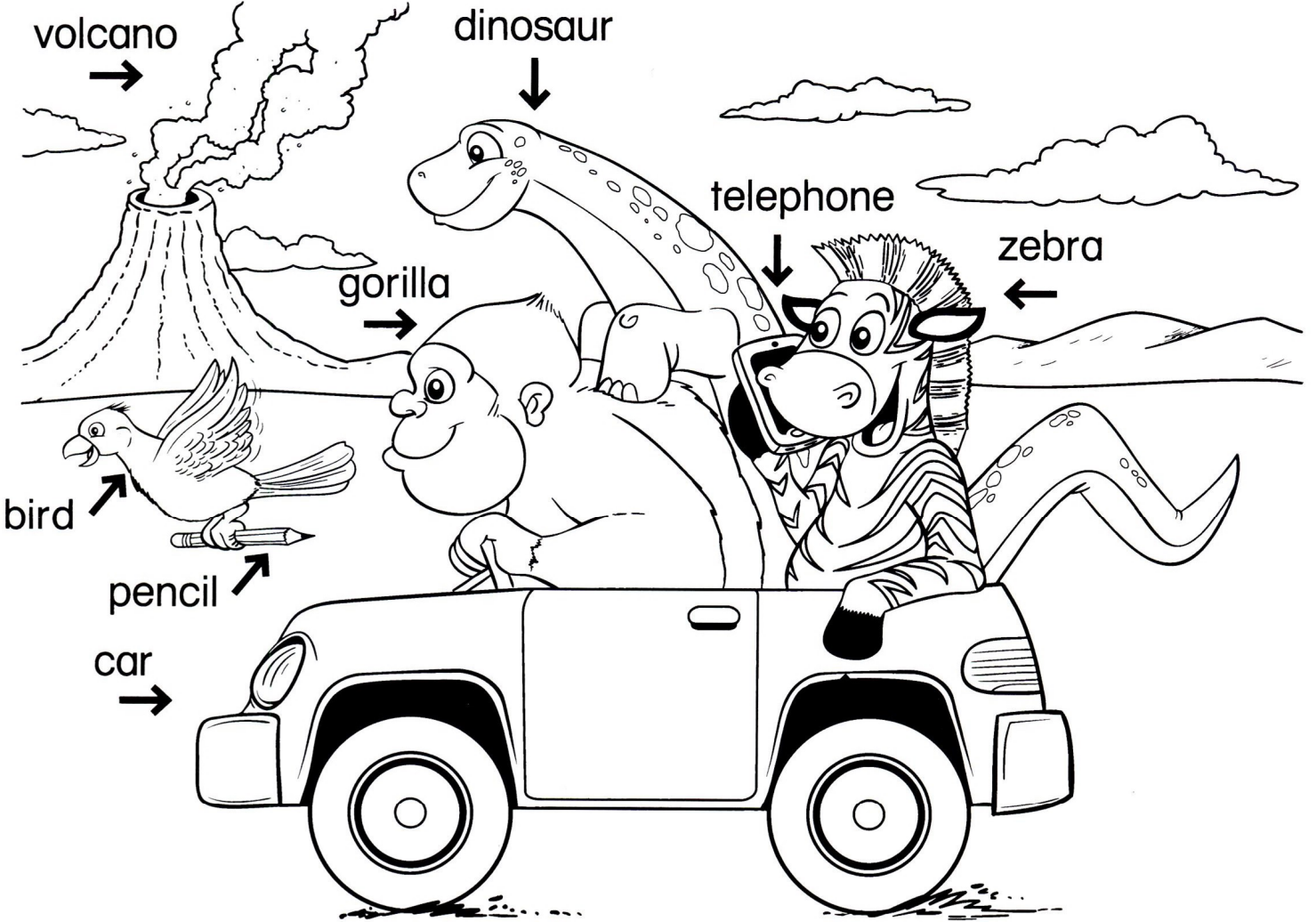

Bb

Cc

Dd

Gg

Pp

Tt

Vv

Zz

✓ Parent's signature: \_\_\_\_\_



Color. Trace.

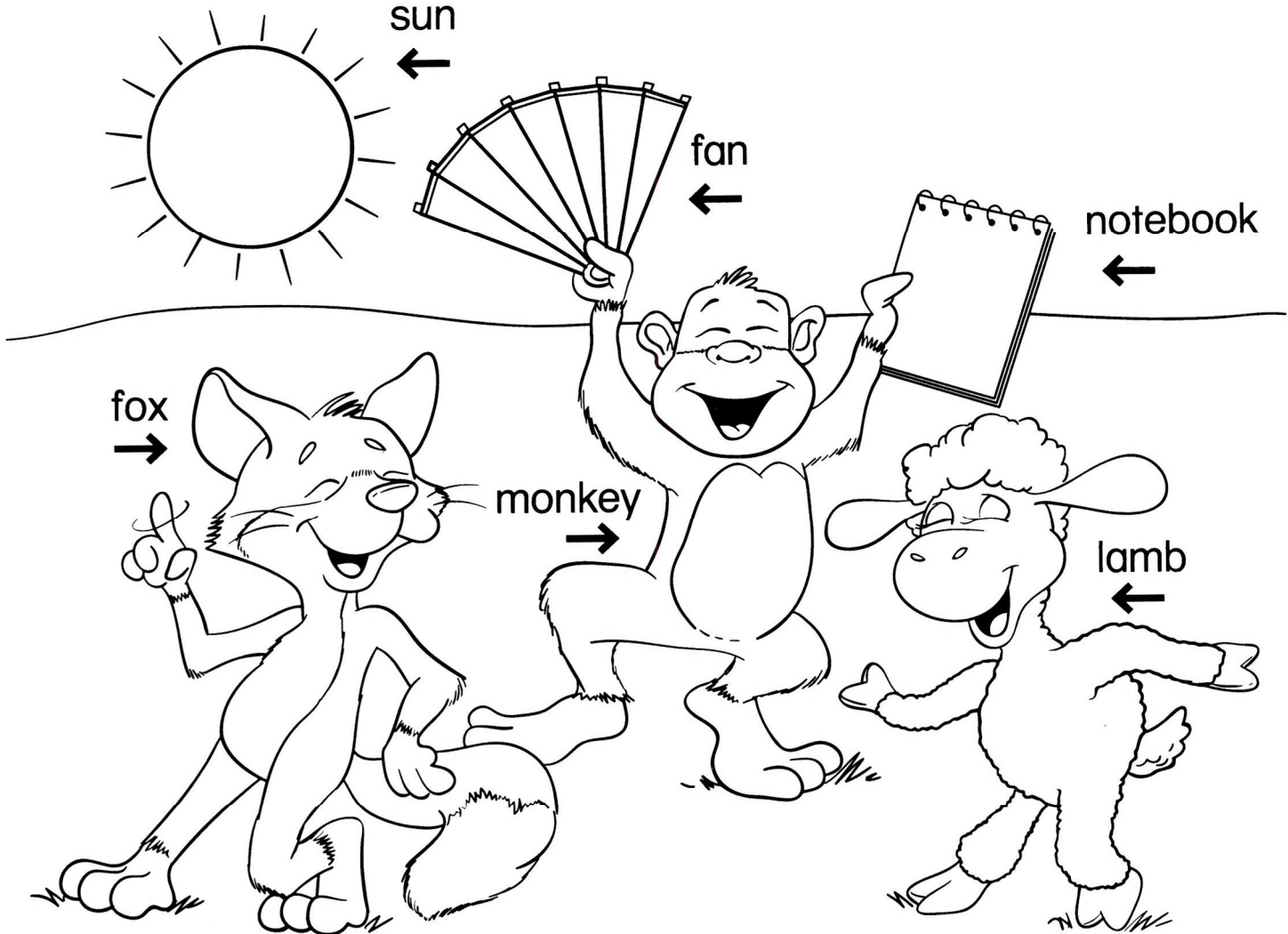

Ff

Ll

Mm

Nn

Ss

Xx

# The EI Group

## D Color. Trace.

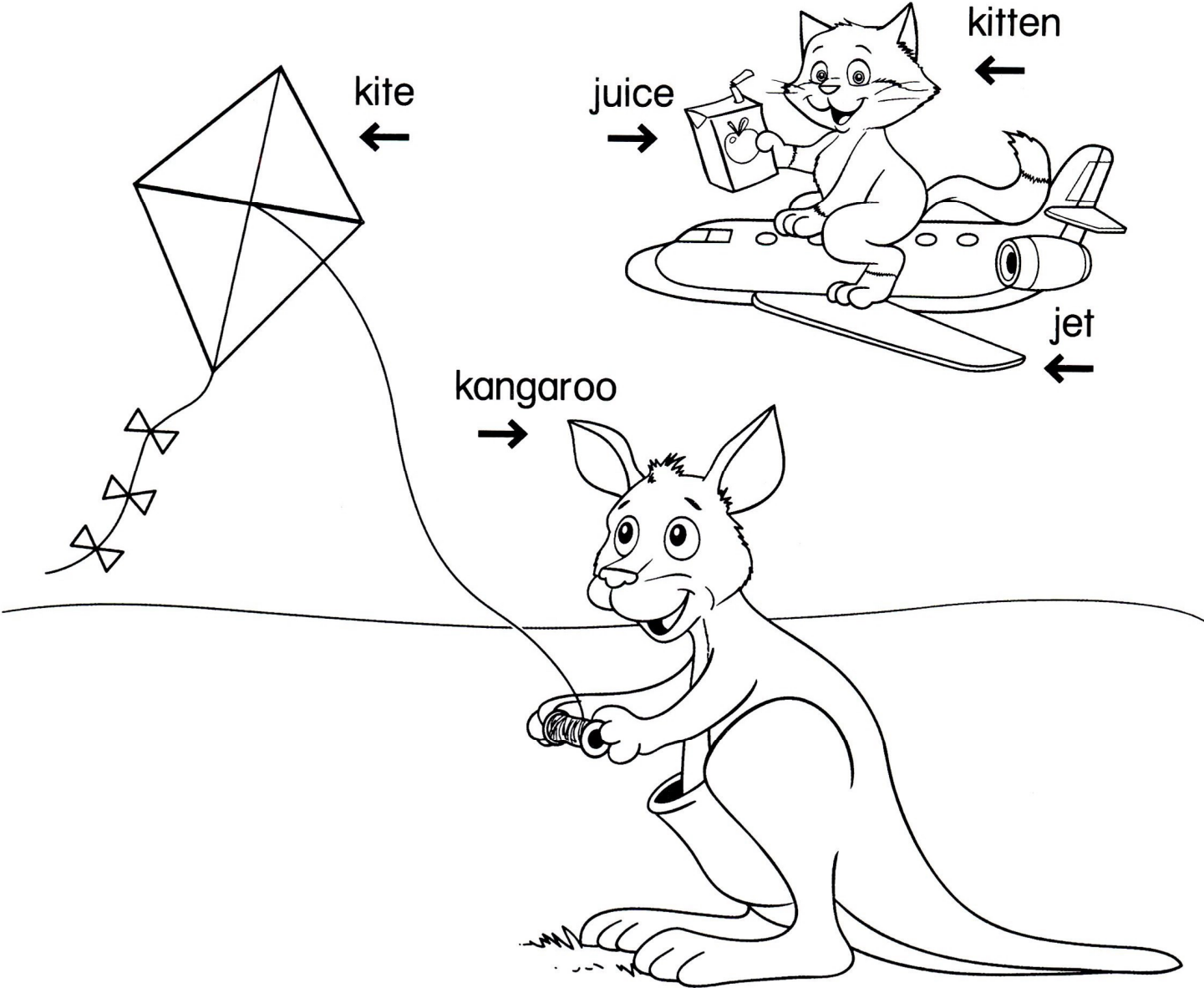

Jj

Kk

✓ Parent's signature: \_\_\_\_\_



# The Mixed Group

## E Color. Trace.

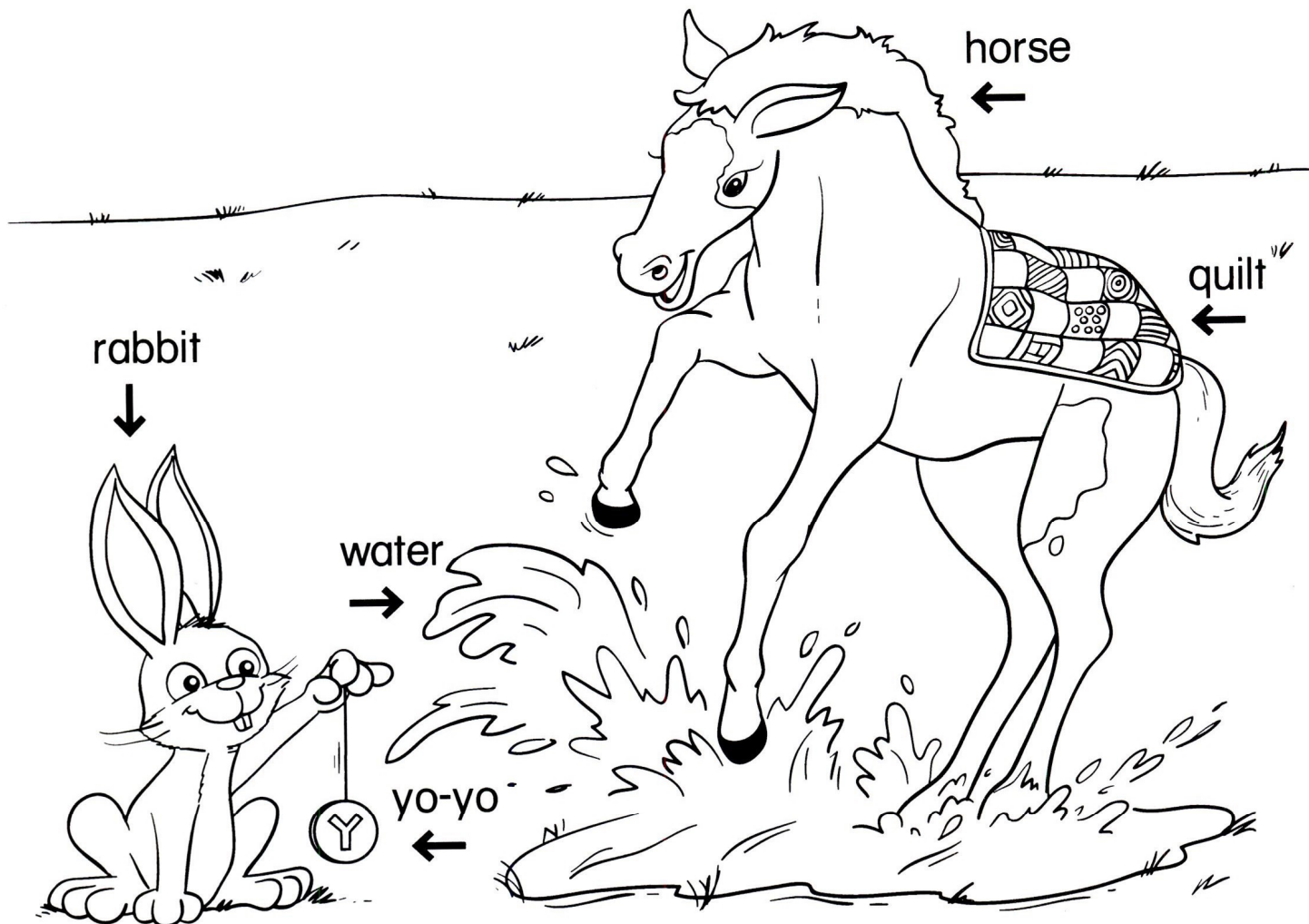

Hh

Qq

Rr

Ww

Yy



Oxford University Press is the world's authority on the English language.

As part of the University of Oxford, we are committed to furthering English language learning worldwide.

We continuously bring together our experience, expertise and research to create resources such as this one, helping millions of learners of English to achieve their potential.



## Let's talk. Let's learn. Let's Go!

Energize your English classes with the trusted methodology of **LET'S GO**.

**LET'S GO** is full of fun, collaborative activities that get students talking in English from the very beginning.

- NEW** **Animated videos:** conversations, songs, and chants create excitement in class and motivate students to speak in English
- NEW** **Teacher's Resource Center:** Online Practice and an extensive online library of easy-to-access teaching resources help get the most out of each class
- NEW** **Can-do statements:** can-do statements with supporting activities allow students to measure their progress
- NEW** **Let's Begin series:** a two-level introductory course provides the perfect building blocks for learning English



### Students

- **Student Book**
- **Workbook**  
Online Practice
- **Online Play**  
Student's Website



### Teachers

- **Teacher's Pack**  
Classroom Presentation Tool, Teacher's Guide, and Teacher's Resource Center
- **Class Audio CDs**
- **Teacher Cards**



[www.irLanguage.com](http://www.irLanguage.com)

**OXFORD**  
UNIVERSITY PRESS

[www.oup.com/elt](http://www.oup.com/elt)

